

Design e funzionalità hanno portato verso un nuovo obiettivo progettuale. Differenti soluzioni estetiche e funzionali vengono coordinate in un'unica collezione che riesce a legare armonicamente obiettivi e materiali. L'ampia gamma di finiture disponibili e le diverse tipologie di modularità, permettono di creare progetti cucina personalizzati sulle esigenze dell'utente. Lo stesso progetto può essere adattato a tutte le finiture senza subire sostanziali variazioni. L'apertura a molteplici soluzioni è sempre finalizzata a soddisfare tutte le necessità funzionali, ergonomiche ed estetiche.

**Ak\_Project**, un sistema completo.

Design and functionality have led towards a new project objective. Different functional and aesthetic solutions are brought together in a single collection that succeeds in harmonising objectives and materials. The wide range of finishes available and the various types of modularity allows that kitchen projects can be created based on the needs of the user. The same project can be adapted in all finishes without undergoing substantial variations. The multiple opening systems solutions are always aimed to satisfying all functional, ergonomic and aesthetic requirements.

**Ak\_Project**, a complete system.

Design et fonctionnalité ont conduit à un nouvel objectif de conception. Des solutions esthétiques et fonctionnelles différentes sont assorties dans une collection unique qui parvient à allier harmonieusement les matériaux et les objectifs. La vaste gamme de finitions disponibles et les différents types de modularité permettent de créer des modèles de cuisine sur mesure pour les besoins de l'utilisateur. Ce même projet peut être adapté à toutes les finitions sans subir des changements importants. La capacité totale de s'ouvrir à une multitude de solutions a toujours pour objectif de répondre à tous les besoins fonctionnels, ergonomiques et esthétiques.

**Ak\_Project**, un système complet.

Design y funcionalidad han creado un nuevo reto en el ámbito del diseño. Diferentes soluciones estéticas y funcionales se coordinan en una sola colección que puede unir armónicamente objetivos y materiales. La amplia gama de acabados disponibles y los diferentes tipos de modularidad permiten crear diseños de cocina personalizados teniendo en cuenta las necesidades del usuario. El mismo diseño se puede adaptar a todos los acabados sin sufrir cambios sustanciales. La apertura a múltiples soluciones tiene siempre como objetivo satisfacer todas las necesidades funcionales, ergonómicas y estéticas.

**Ak\_Project**, un sistema completo.

Design: Arch. Franco Driusso

**Ak\_Project**

# Ak\_Project

INDICE  
INDEX

**MELAMINICI**  
MELAMINE

**01** 04-19

**02** 20-35

**03** 36-51

**04** 52-65

**05** 66-79

Architecture

**TECNOLUX**

Architecture

**06** 80-93

**FENIX NTM®**

Architecture

**07** 94-109

**LACCATI**  
LAQUERED  
**ROVERE SPAZZOLATO**  
BRUSHED OAK  
**ACCIAIO**  
STEEL

**08** 110-123

**09** 124-139

**10** 140-153

**11** 154-167

**12** 168-181

Architecture

Architecture

01

MELAMINICO TERMOSTRUTTURATO MORO  
THERMOSTRUCTURED MELAMINE MORO

MELAMINICO SUPERMATT SHADOW  
SUPERMATT MELAMINE SHADOW

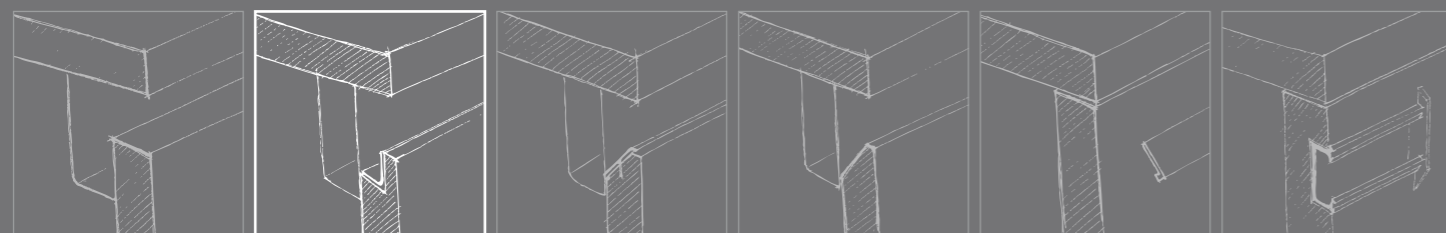
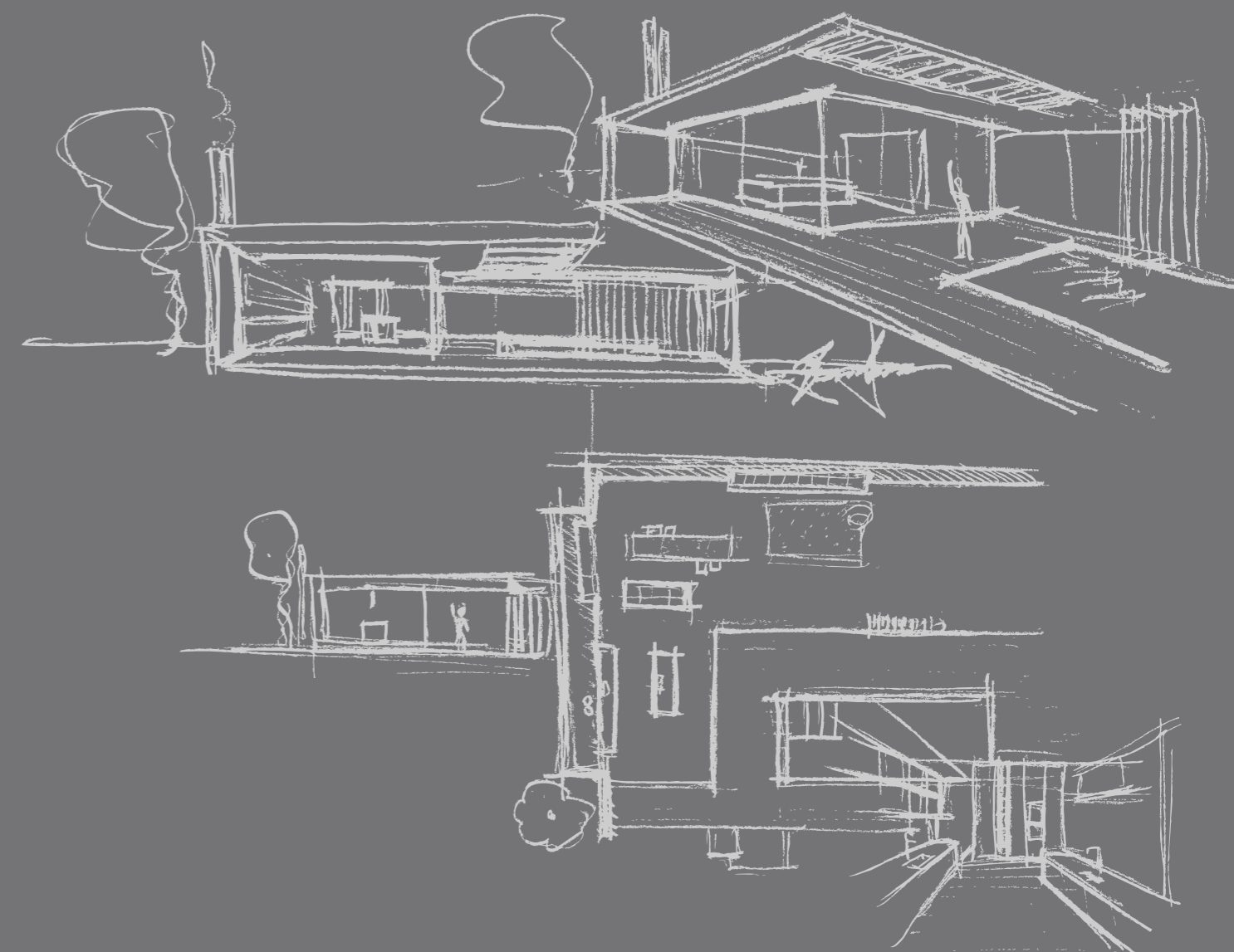







La cucina diventa protagonista dello spazio abitativo caratterizzandone anche la zona living.

Il sistema delle vetrine "Gem", declinato in versione pensile sopra l'area di lavoro, presenta un'illuminazione interna a LED che ne sottolinea la finitura ed enfatizza il contenuto.

Il piano di lavoro viene lavorato con bordo anteriore inclinato.

Kitchen become the protagonist of the home, at the same time characterising the living space.

The "Gem" vetrina's system, also used as a wall cabinet above the working area has an internal LED lighting system which highlights the finish and emphasizes the contents.

The worktop is made with an inclined front edge.

La cuisine devient la star de l'espace de vie aussi tout en caractérisant la zone living.

Le système de vitrines "Gem", décliné en version suspendue au-dessus de la zone de travail, présente un éclairage à intérieur à LED pour une finition bien en évidence et une focalisation sur le contenu.

Le plan de travail est fini avec un chant visible incliné.

La cocina vuelve a ser protagonista del espacio donde vivimos y caracteriza también la zona living.

El sistema de las vitrinas "Gem", disponible en versión mueble colgante, presenta una iluminación interna de LED que pone en evidencia el acabado y enfatiza el contenido.

La encimera tiene el canto delantero inclinado.

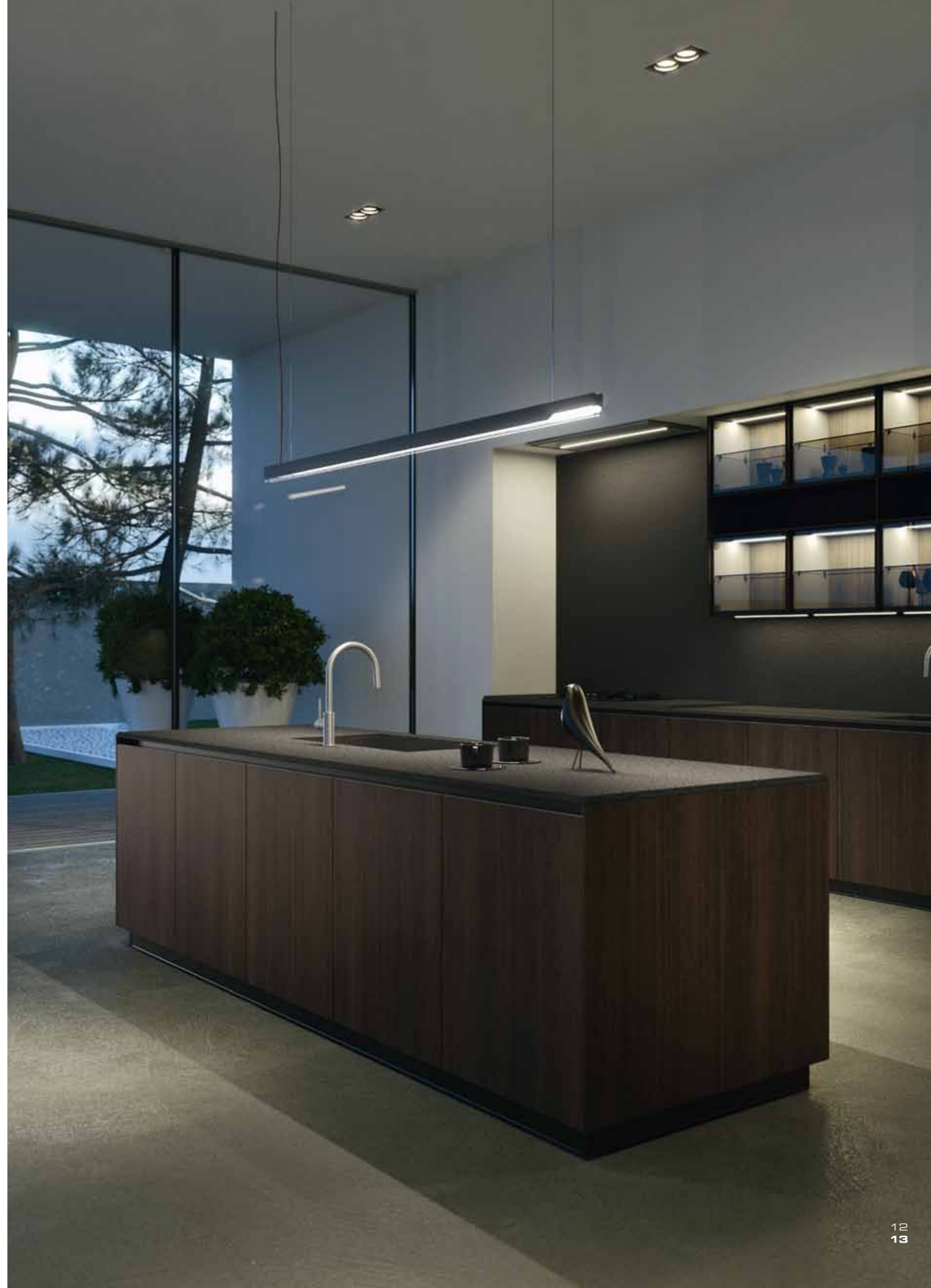









Nuovi cestoni con sponde laterali da 25 cm più pratici e contenitivi.

Gli elementi compositivi si arricchiscono di ampie possibilità di suddivisione degli spazi interni.

De nouveaux coulissants avec réhausses latérales de 25 cm plus pratiques et avec plus d'espace de rangement.

Les éléments modulaires sont enrichis de nombreuses possibilités d'agencement des espaces intérieurs.

New baskets with 25 cm height sides are more practical and more capacious.

These elements are enriched by the numerous opportunities to subdivide the inner spaces.

Nuevas gabetas con laterales de h. 25 cm, más prácticos y con más capacidad.

Los elementos de la composición se enriquecen con amplias posibilidades de subdivisión de los espacios internos.



02

MELAMINICO TERMOSTRUTTURATO SESAMO  
THERMOSTRUCTURED MELAMINE SESAMO  
MELAMINICO TERMOSTRUTTURATO ETNA  
THERMOSTRUCTURED MELAMINE ETNA

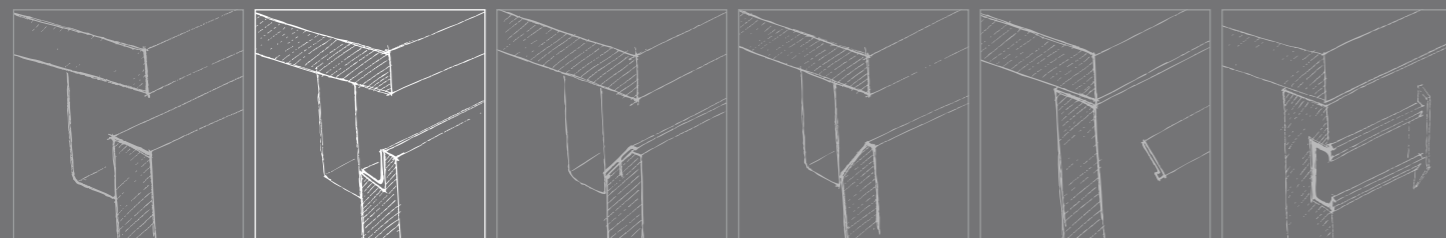
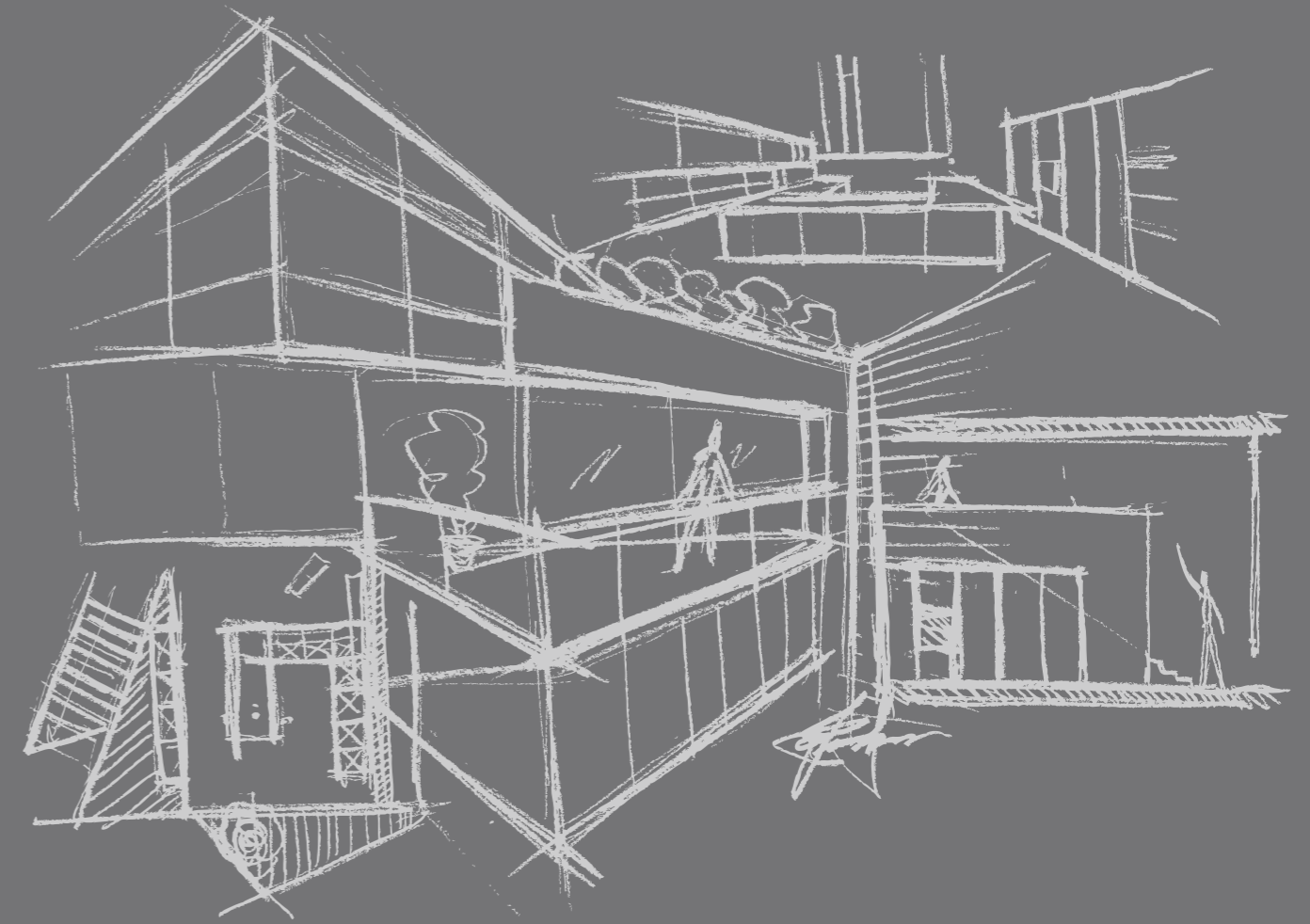







Forme essenziali per questa soluzione compositiva caratterizzata da contrasti cromatici e materici.

Il sistema comprende la modularità 75/105 cm ampliando la capacità contenitiva delle basi anche nel caso dell'inserimento di elettrodomestici.

Essential shapes for this solution, are characterised by chromatic and materic contrasts.

The system includes the 75/105 cm modules, increasing containing capacity of the base units even when appliances are installed.

Des formes essentielles pour cette solution d'agencement caractérisée par des contrastes chromatiques et de matières.

Le système comprend la modularité 75/105 cm qui augmente la capacité de rangement des meubles bas même pour l'encastrement des électroménagers.

Formas esenciales para esta solución de composición que se caracteriza por los contrastes de colores y materiales.

El sistema incluye la modularidad 75/105 cm ampliando la capacidad de almacenamiento de los muebles bajos también incluyendo unos electrodomésticos.









Una zona cottura ad induzione integrata a filo top sottolinea la linearità dei volumi.

La lavorazione dell'anta a "Step" conferisce maggior leggerezza e pulizia alla composizione.

Une plaque de cuisson à induction à fleur de plan met en évidence la linéarité des volumes.

La conception de la porte "Step" donne plus de légèreté et de propreté à la composition.

An induction cooking area flush with the worktop underlines the linear nature of the spaces.

The "Step" handle profile doors, gives a lighter and cleaner feel to the composition.

Una zona de cocción de inducción integrada al ras de la encimera destaca la linealidad de los volúmenes.

La puerta "Step" aporta más ligereza y limpieza a la composición.





Gli elementi modulari "DayBox" estendono la capacità contenitiva alla zona living diventando oggetti d'arredo.

Les éléments modulaires "DayBox" vont agrandir la capacité de rangement pour la zone living en devenant des objets de décoration mobilière.

The modular "DayBox" elements extend the containing capacity of the living space and are also a decorative element.

Los elementos modulares "DayBox" amplían la capacidad de almacenamiento convirtiéndose en objetos de decoración.



03

MELAMINICO TERMOSTRUTTURATO BASALTO  
THERMOSTRUCTURED MELAMINE BASALTO

SUPERMATT SHADOW  
SUPERMATT SHADOW

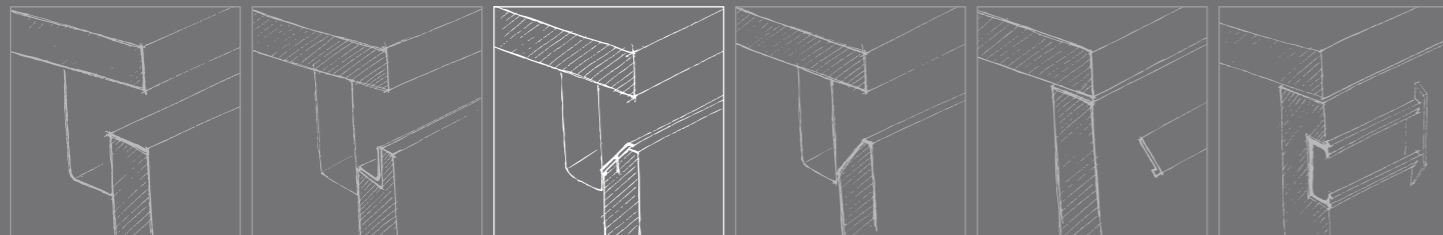
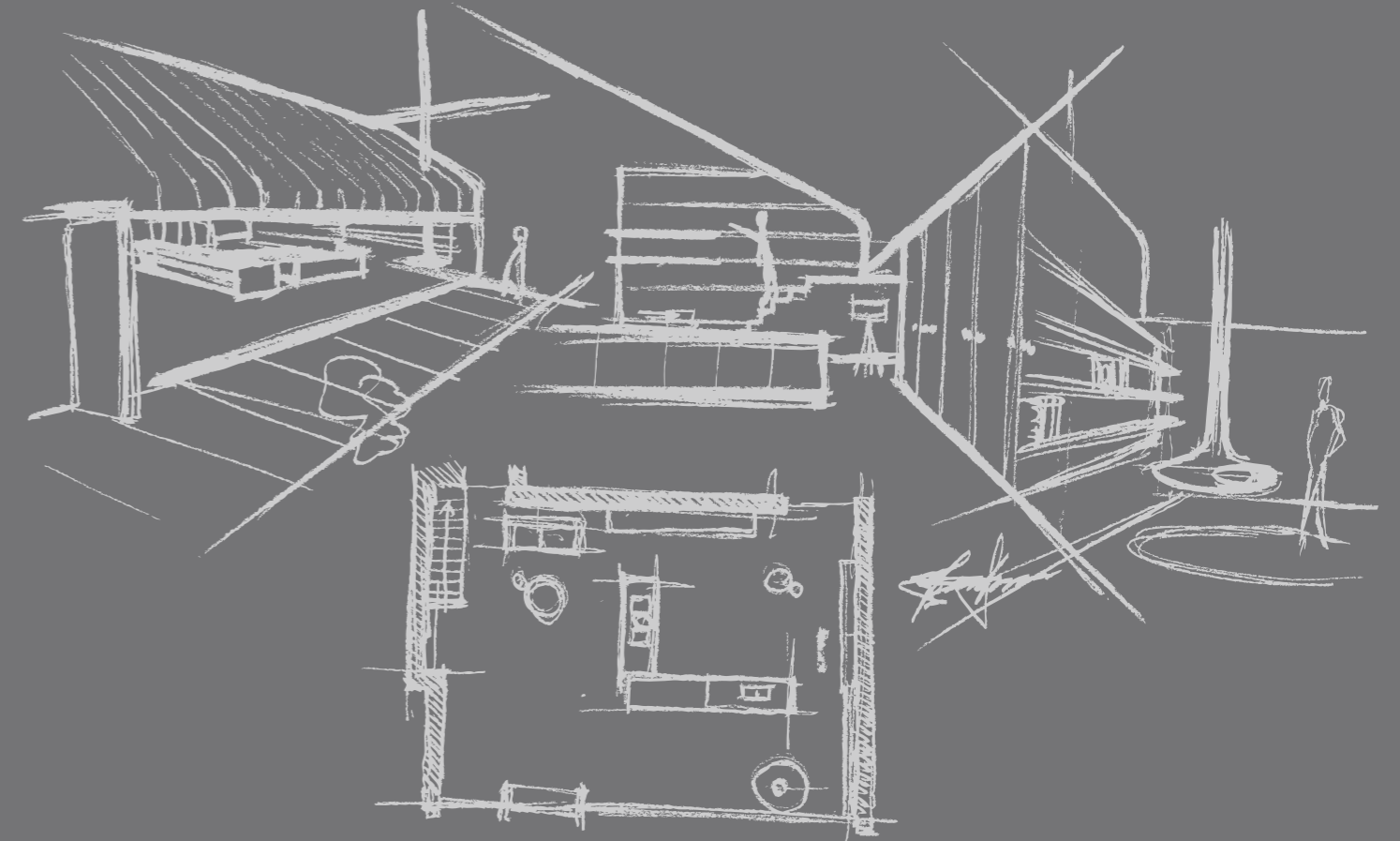







L'isola è caratterizzata da una zona cottura modulare intervallata da cappe aspiranti integrate.

Il modulo Barbecue con griglia e pietra lavica completa piacevolmente la composizione.

L'îlot est caractérisé par une zone de cuisson modulaire et par des hottes aspirantes intégrées.

Le module Barbecue avec grill et pierre de lave complète agréablement la composition.

The island is characterised by a modular cooking area intervalled by integrated extractor hoods.

The Barbecue module with grill and lava rock completes the composition in a pleasing way.

La isla se caracteriza por una zona de cocción modular intercalada con campanas extractoras integradas.

El módulo Barbecue con parrilla y piedra de lava completa agradablemente la composición.







La boiserie "Strato" diventa un accessorio che in questa composizione viene proposto sia a parete che come finitura retro basi.

Gli eleganti accostamenti cromatici dei materiali scelti rendono l'ambiente dinamico e accogliente.

The boiserie system named "Strato" becomes an accessory that, in this composition, is presented in both options, as wall one, and base cabinets's rear finish panel.

The elegant chromatic juxtapositions of the materials chosen makes the environment feel dynamic and welcoming.

La boiserie "Strato" devient un accessoire que dans cette composition est proposée soit sur paroi que comme finition arrière des meubles bas.

Les élégantes associations chromatiques des matériaux choisis en font un espace de vie dynamique et accueillant.

La boiserie "Strato" se convierte a ser un accesorio que, en esta composición, se propone tanto de acabado de la parte posterior del mueble bajo.

Las elegantes combinaciones de colores de los materiales elegidos hacen el ambiente dinámico y acogedor.





Le colonne con ante rientranti lasciano piena libertà di azione. Diverse soluzioni interne soddisfano le necessità quotidiane in cucina.

Les colonnes avec portes rentrantes laissent toute liberté d'action. Des solutions internes différentes répondent aux besoins quotidiens dans la cuisine.

The columns with retracting doors, allow for entirely free movement. Different internal solutions satisfy all daily needs in the kitchen.

Las columnas con puertas escamoteables dejan plena libertad de acción. Diferentes soluciones internas cubren las necesidades diarias en la cocina.





04

MELAMINICO TERMOSTRUTTURATO SHERWOOD  
THERMOSTRUCTURED MELAMINE SHERWOOD

MELAMINICO TERMOSTRUTTURATO WALL51  
THERMOSTRUCTURED MELAMINE WALL51

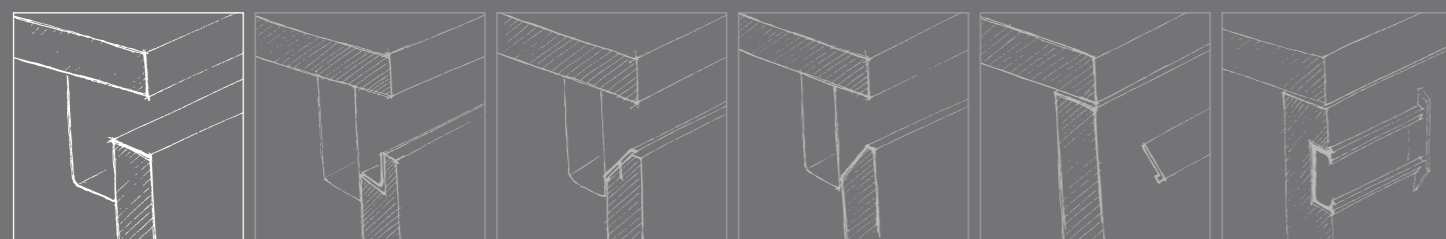
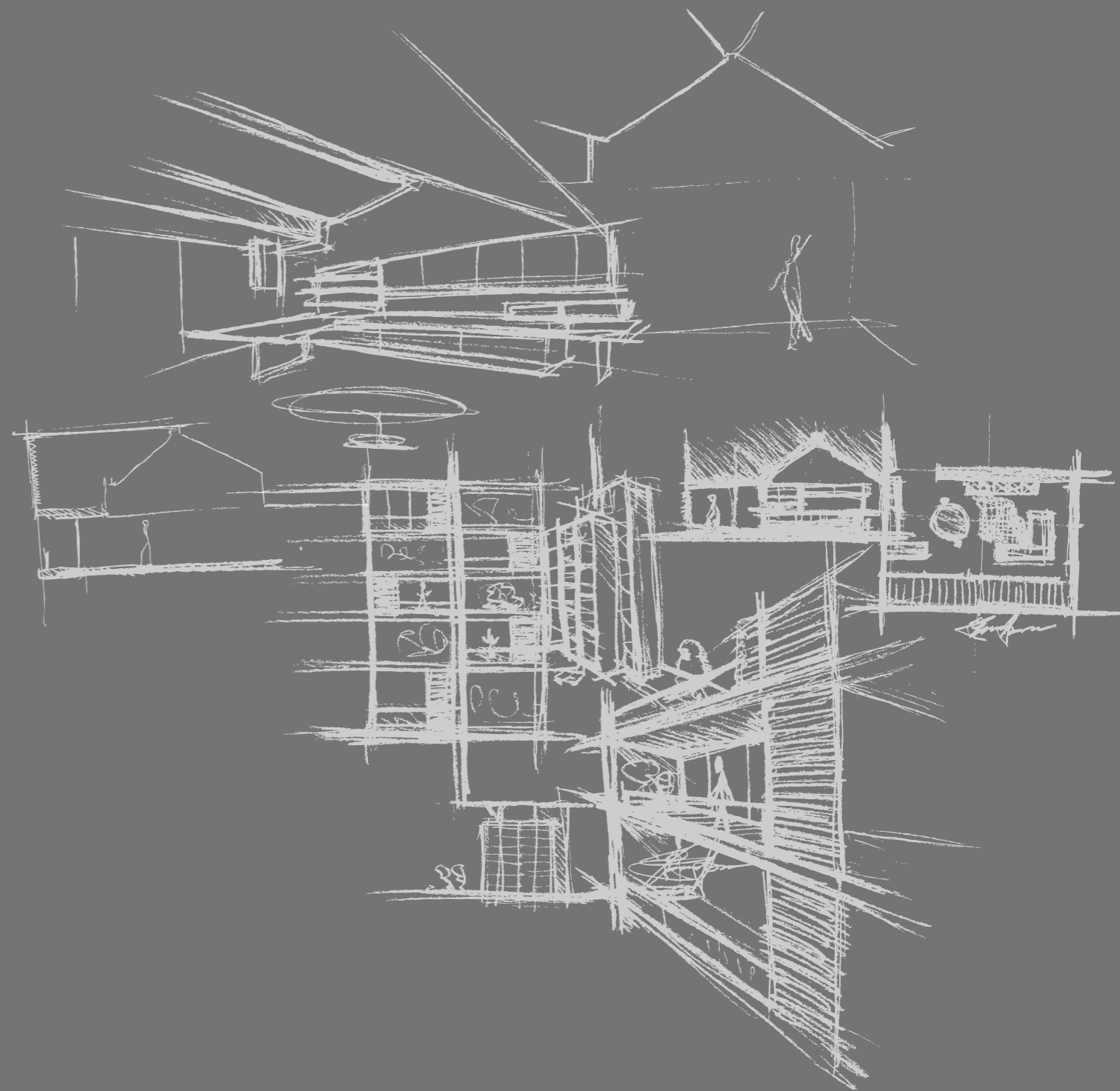







Composizione lineare impreziosita dalla scelta delle finiture in melaminico Wall51 e Sherwood che rendono le superfici materiche e vibranti.

L'elemento a giorno in finitura Sherwood scandisce la sequenza delle colonne attrezzate con elettrodomestici.

A linear composition enriched by the choice of Wall51 and Sherwood melamine finishes, which make the surfaces materic and vibrant.

The open shelf element with Sherwood finish defines the sequence of cabinets equipped with appliances.

Composition linéaire améliorée par le choix des finitions en mélaminé Wall51 et Sherwood qui rendent les surfaces pleines de texture et de vibration.

L'élément ouvert dans la finition Sherwood marque la séquence de colonnes équipées avec des électroménagers.

Composición lineal enriquecida por la elección de los acabados en melamínico Wall51 y Sherwood que hacen las superficies matéricas y vibrantes.

El elemento abierto en acabado Sherwood marca la secuencia de las columnas equipadas con electrodomésticos.





Il piano a sbalzo, sostenuto dal gambone in vetro, viene impreziosito dal contenitore "AkB\_Case", in finitura grigio Ardesia e vetri fumè Bronzo.

Le plan de travail avec débordement, soutenu par le pied en verre, est complété par le conteneur "AkB\_Case", en finition gris Ardesia et des verres fumè Bronzo.

The cantilever top, supported by a glass leg, is enriched by the "AkB\_Case" container, in grey Ardesia finish and fumè Bronzo glazing.

La encimera volada, sostenida por la pata de vidrio, está enriquecida por el contenedor "AkB\_Case", en acabado gris Ardesia y vidrios fumè Bronzo.







05

MELAMINICO TERMOSTRUTTURATO DAINO  
THERMOSTRUCTURED MELAMINE DAINO

MELAMINICO SUPERMATT CRETA  
SUPERMATT MELAMINE CRETA

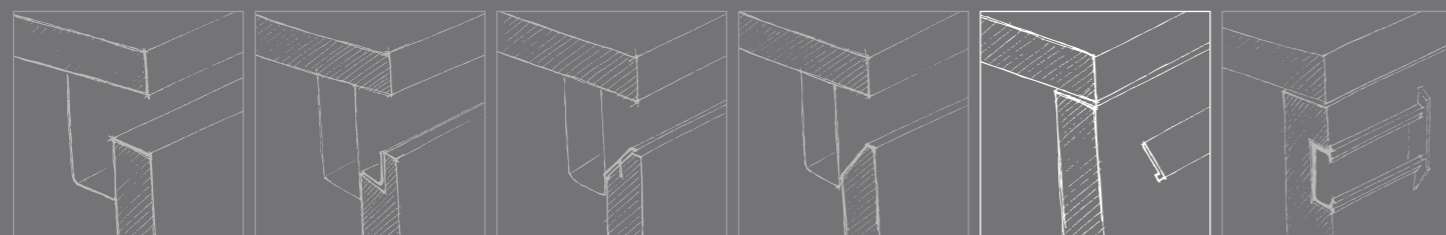
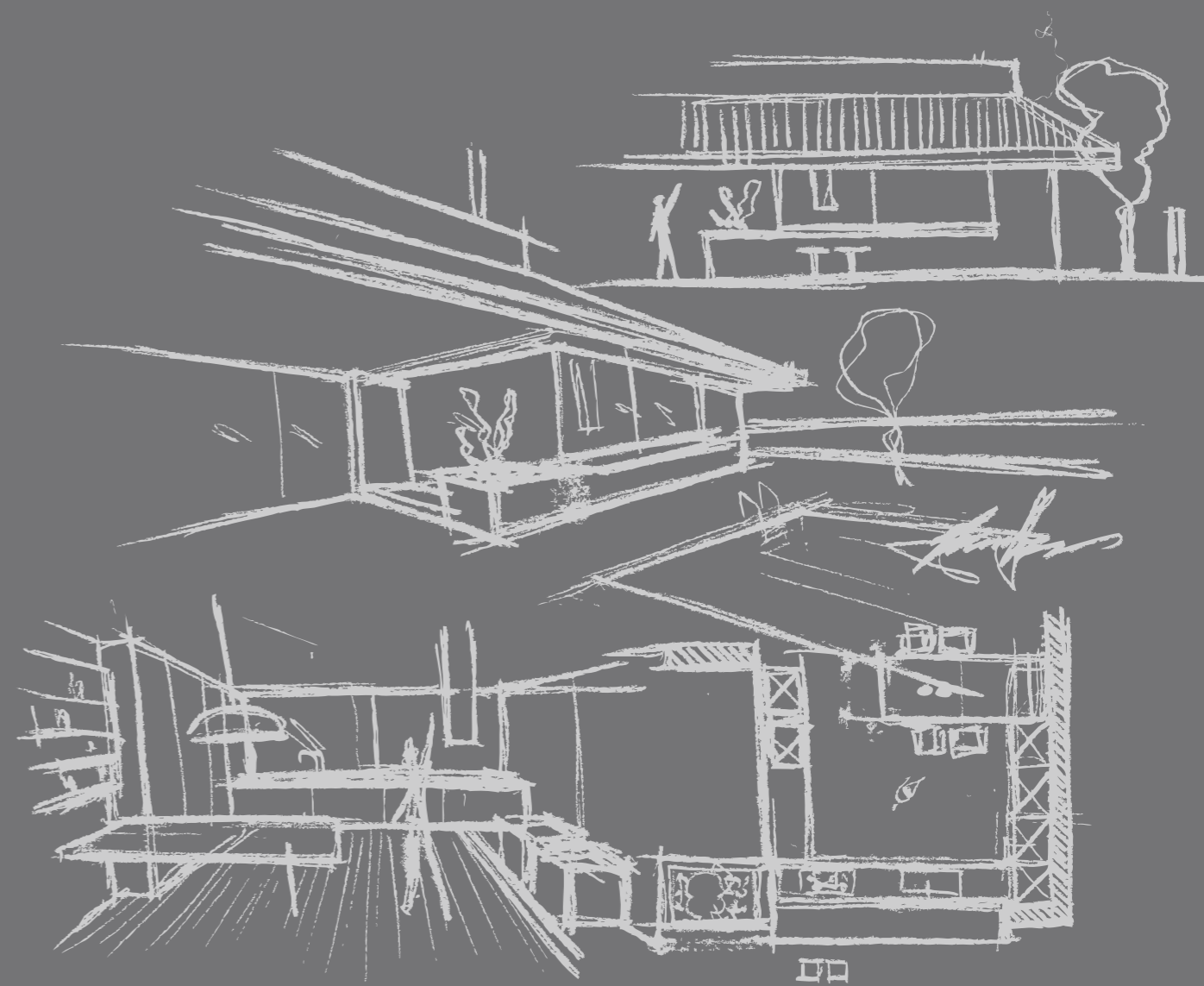







La leggerezza visiva della composizione è sottolineata dall'utilizzo di basi sospese.

Meccanismo con cestelli ad estrazione per sfruttare pienamente gli spazi d'angolo.

The visual lightness of the composition is underlined by the use of suspended bases.

Pull-out baskets stands out and allows maximum use of the corner.

La légèreté visuelle de la composition est accentuée par l'utilisation de meubles bas suspendus.

Paniers coulissants pour exploiter au maximum l'espace d'angle.

La ligereza visual de la composición está evidenciada por el uso de muebles bajos suspendidos.

Mecanismo con cestos extraíbles para aprovechar de todos los espacios disponibles en ángulo.



I pratici elementi contenitivi "DayBox" sovrapposti a parete, sono in finitura Alluminio con schiena in melaminico Daino.

Les éléments de rangement pratiques "DayBox" superposés sur paroi, sont en finition aluminium avec dos mélaminé Daino.

The practical "DayBox" container elements, overlapping on the wall, are finished in aluminium with a Daino melamine back.

Los prácticos elementos contenedores "DayBox", sobrepuestos a pared, están en acabado en Aluminio con trasera de melamínico Daino.

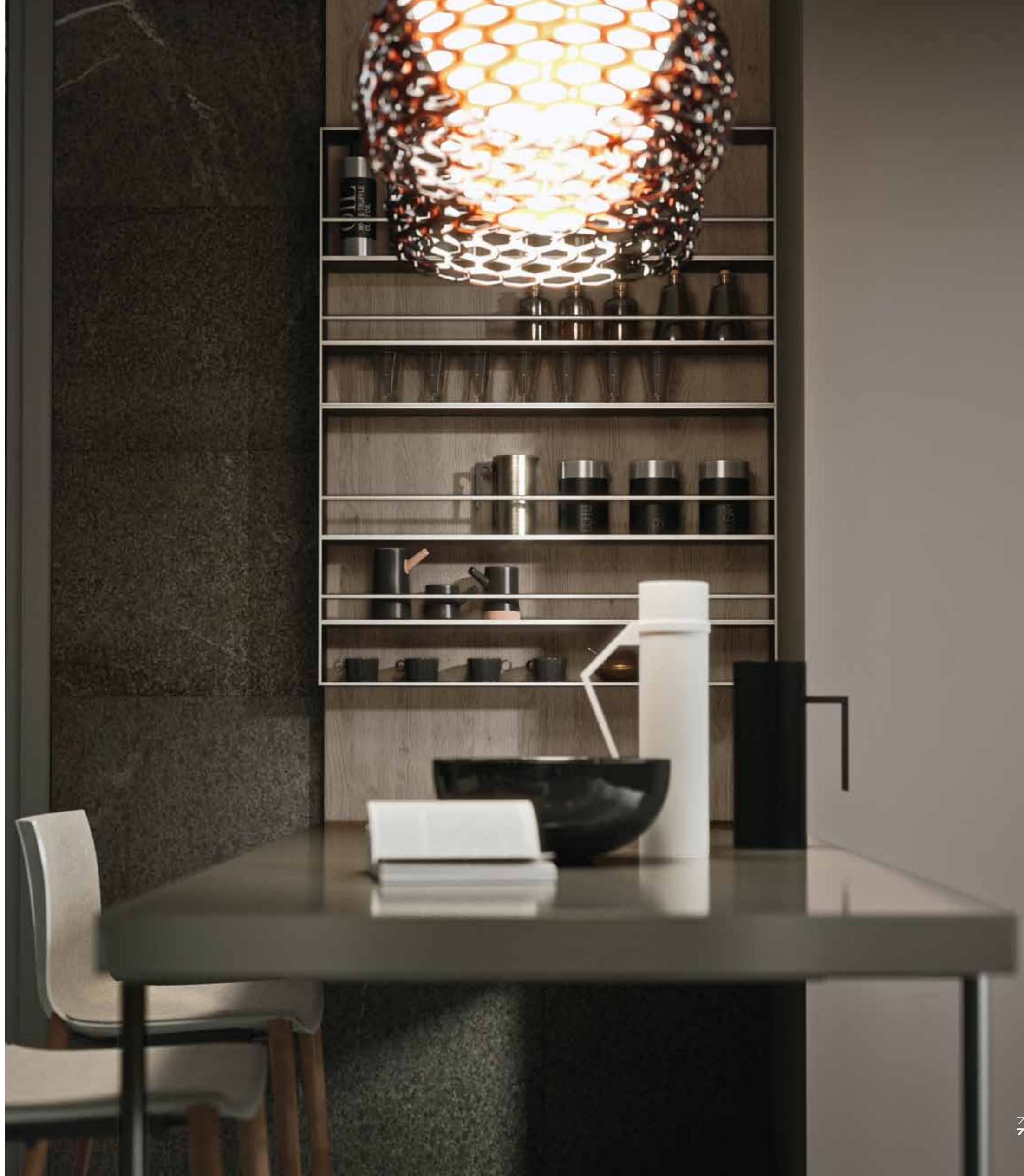



La maniglia modulare in tondino finitura acciaio garantisce una pratica apertura.

The modular rod handles, with a steel finish, ensure practical opening.

La poignée barre arrondie finition acier garantit une ouverture pratique.

El tirador modular acabado acero garantiza una apertura práctica.





Le cantine sono "avvolte" da un rivestimento in melaminico Daino come le ante.

Il gambone in acciaio sostiene il pratico bancone.

Les caves à vins sont pour ainsi dire "enveloppées" par un revêtement en mélamine Daino comme les portes.

Le pied en acier sert de support au plan pratique.

The wine racks are "wrapped" in a melamine Daino coating, like the doors.

The steel leg supports the practical bench.

Las vinotecas están forradas por un revestimiento de melamina Daino como las puertas.

La pata de acero sostiene el práctico mostrador.





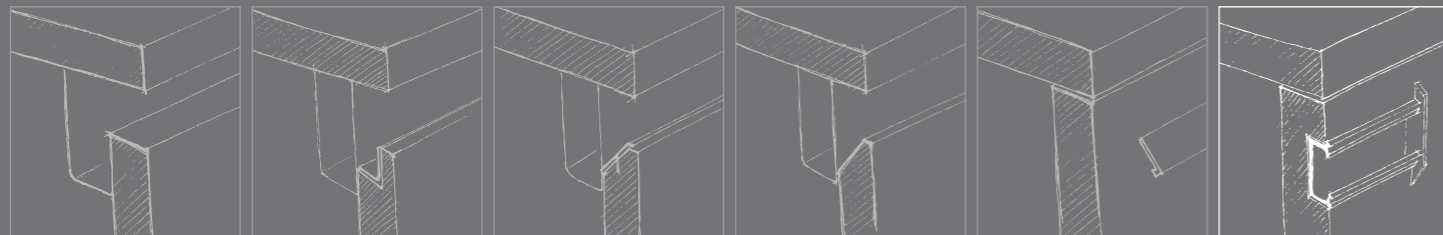
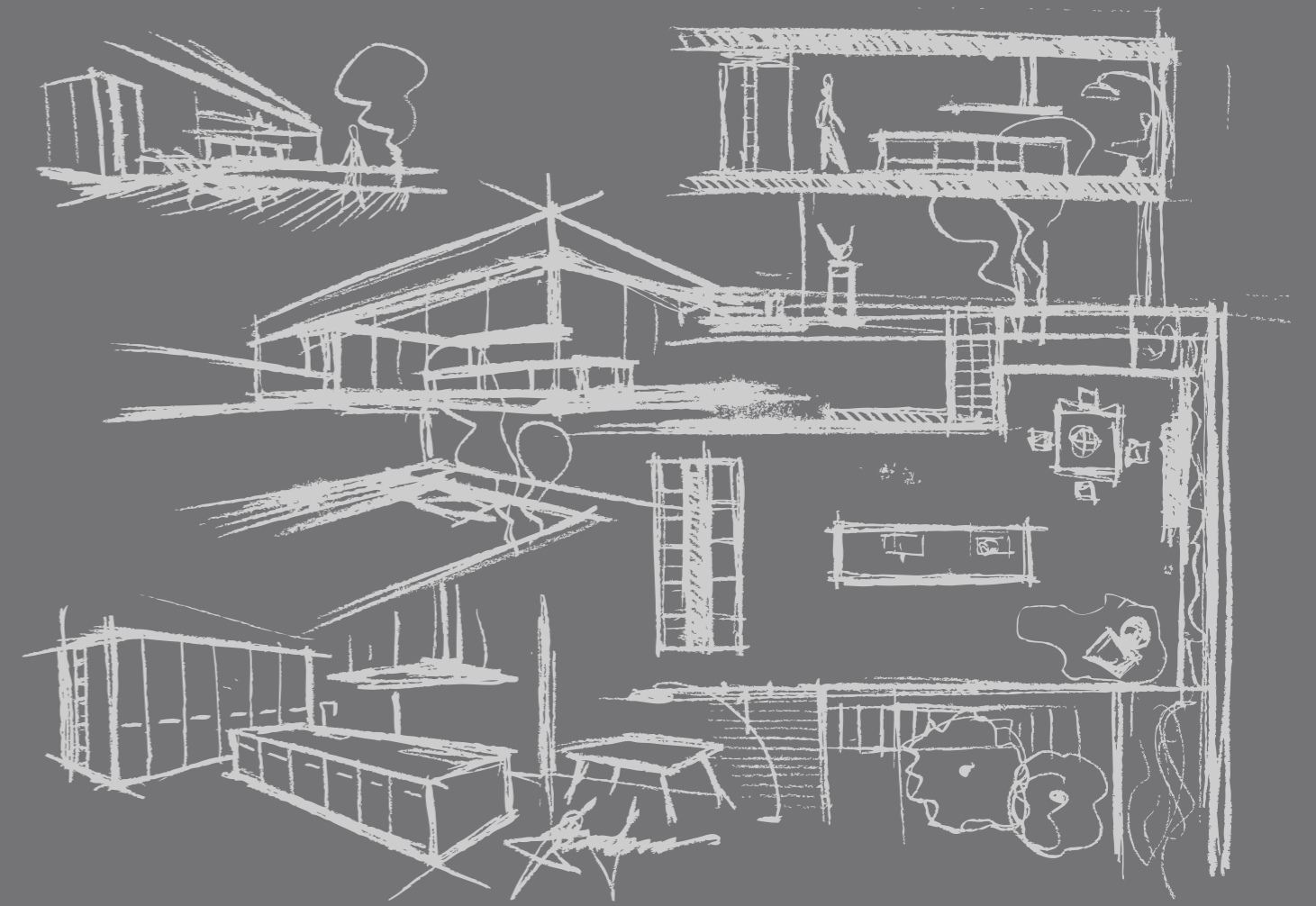







Il gruppo colonne con ante rientranti ospita gli elettrodomestici, i vani contenitori e una pratica zona operativa.

L'illuminazione interna è inserita in modo da essere funzionale all'utilizzo di questo spazio.

Le groupe de colonnes avec portes rentrantes héberge les électroménagers, les compartiments de rangement et un espace de travail pratique.

L'éclairage d'intérieur est insérée pour en assurer la fonctionnalité en vue de l'utilisation de cet espace.

Tall units with retracting doors, which holds the appliances, the container compartments and a practical working area.

The internal lighting is inserted so as to be functional when using this space.

El grupo de columnas con puertas escamoteables contiene los electrodomésticos, los compartimentos de almacenamiento y una práctica zona operativa.

La iluminación interna está colocada de manera que sea funcional para el uso de este espacio.





Rivestimento per fianchi e top in acciaio satinato alveolare spessore 6 mm, con piano cottura ad induzione integrato a filo e lavello saldato.

Sides and worktops 6 mm thick, coated with alveolar steel, and flush-mounted induction cooking hob and welded sink.

Revêtement pour joues et plan de travail en acier satiné alvéolaire d'épaisseur 6 mm avec plaque de cuisson à induction intégrée et évier soudé.

Paneles de revestimiento para costados laterales y encimeras de acero satinado de 6 mm de espesor con placa de cocción a inducción integrada al ras y fregadero soldado.





Volume essenziale per l'isola operativa con ante in Tecnolux Fumo lucido e top in acciaio satinato.

Maniglia modulare ad incasso con interno in finitura anta.

Essential volume for the working island with Tecnolux Fumo gloss doors and satin steel work top.

Modular recessed handle, where the internal part has the same finish as the doors.

Volume essentiel pour l'îlot opérationnel avec portes en Tecnolux Fumo brillant et plan de travail en acier satiné.

Poignée modulaire encastrée avec l'intérieur en finition de la porte.

Volumen esencial para la isla operativa con puertas de Tecnolux Fumo brillante y encimera de acero satinado.

Tirador modular empotrado con la parte interior en el mismo acabado de la puerta.



07

FENIX NTM® GRIGIO LONDRA  
FENIX NTM® GRIGIO LONDRA

FENIX NTM® NERO INGO  
FENIX NTM® NERO INGO

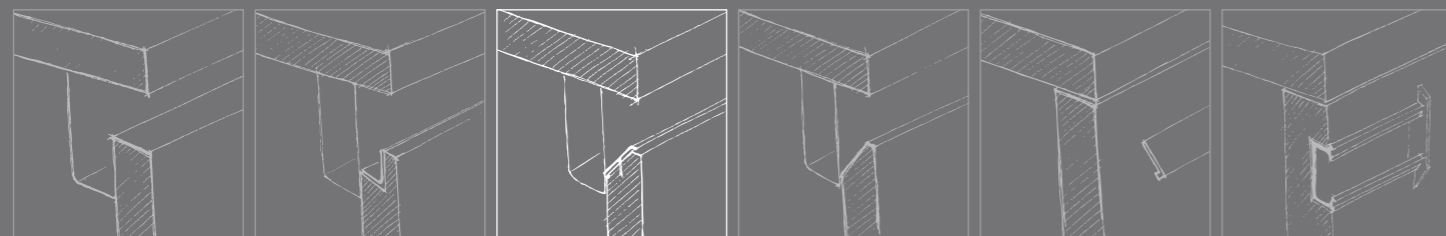
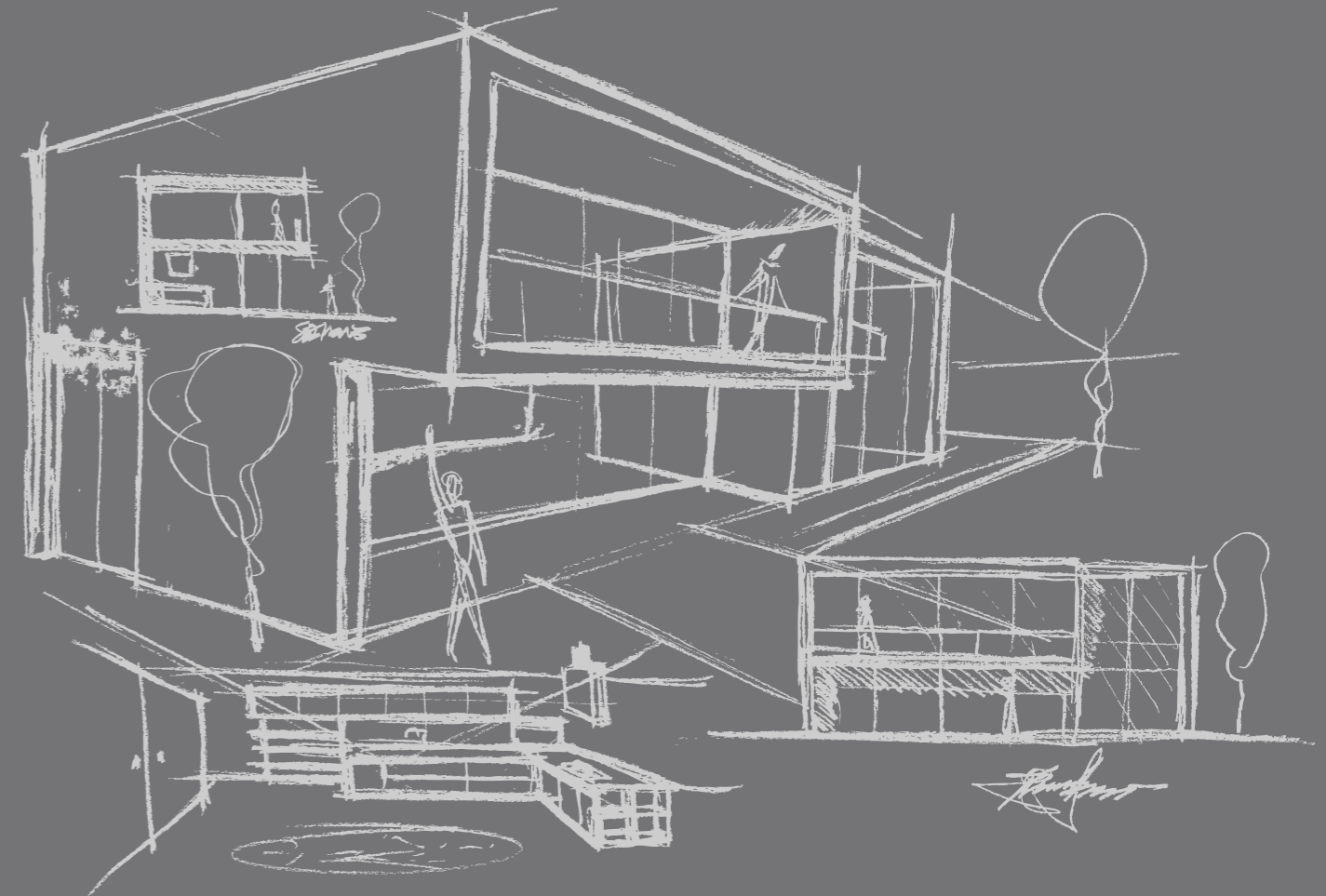









Spazio dinamico, sapientemente articolato per la composizione in Fenix Ntm®. Superfici opache soft-touch anti impronta su tutti gli elementi della cucina contribuiscono alla piacevole sensazione tattile.

Massimo coordinamento di tutti gli accessori, con integrazione della vasca lavello realizzata anch'essa in Fenix Ntm®.

A dynamic space, wisely articulated for the Fenix Ntm® composition. Opaque soft-touch anti-fingerprint surfaces on all elements in the kitchen contribute to the pleasing tactile sensation.

Maximum coordination of all accessories, with the integrated sink also in Fenix Ntm®.

Espace dynamique, soigneusement choisi pour la composition en Fenix Ntm®. Surfaces mates soft-touch anti-traces de doigt sur tous les éléments de la cuisine qui contribuent à cette agréable sensation tactile.

Maximale coordination de tous les accessoires, avec l'intégration de l'évier également fait de Fenix Ntm®.

Espacio dinámico, cuidadosamente articulado para la composición de Fenix Ntm®. Superficies mate soft-touch antihuella en todos los elementos de la cocina contribuyen a una agradable sensación táctil.

Máxima coordinación de todos los accesorios, con la integración de la cubeta del fregadero hecha también de Fenix Ntm®.







Soluzioni funzionali per l'integrazione di accessori.

La boiserie "Strato", gli elementi terminali a giorno e le colonne complanari con maniglia ad incasso, diversificano la capacità contenitiva del sistema.

Des solutions fonctionnelles pour l'intégration des accessoires.

La boiserie "Strato", les éléments terminaux ouverts et les colonnes complanaires avec poignée encastrée, diversifient la capacité de rangement du système.

Functional solutions for integrating accessories.

The boiserie "Strato", open end elements and coplanar units with recessed handles, diversifying the containing capacity of the system.

Soluciones funcionales para la integración de accesorios.

La boiserie "Strato", los elementos terminales abiertos y las columnas complanares con tirador empotrado, diversifican la capacidad de almacenamiento del sistema.





08

ROVERE SPAZZOLATO ARDESIA  
OAK BRUSHED ARDESIA

LACCATO SAND GRIGIO MEDIO  
SAND LACQUERED GRIGIO MEDIO

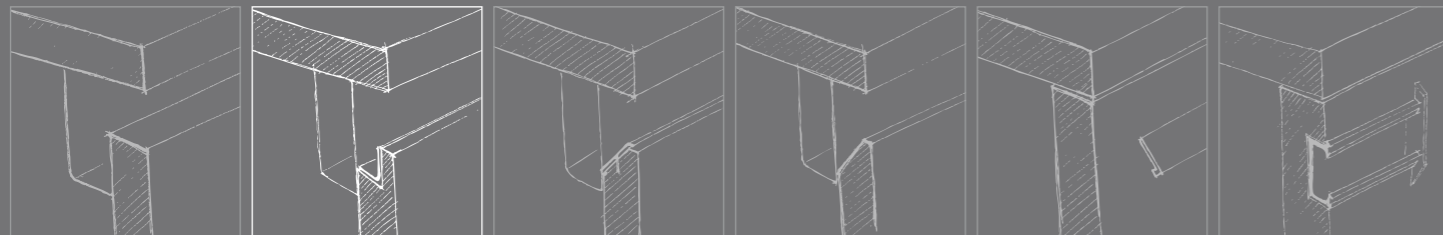
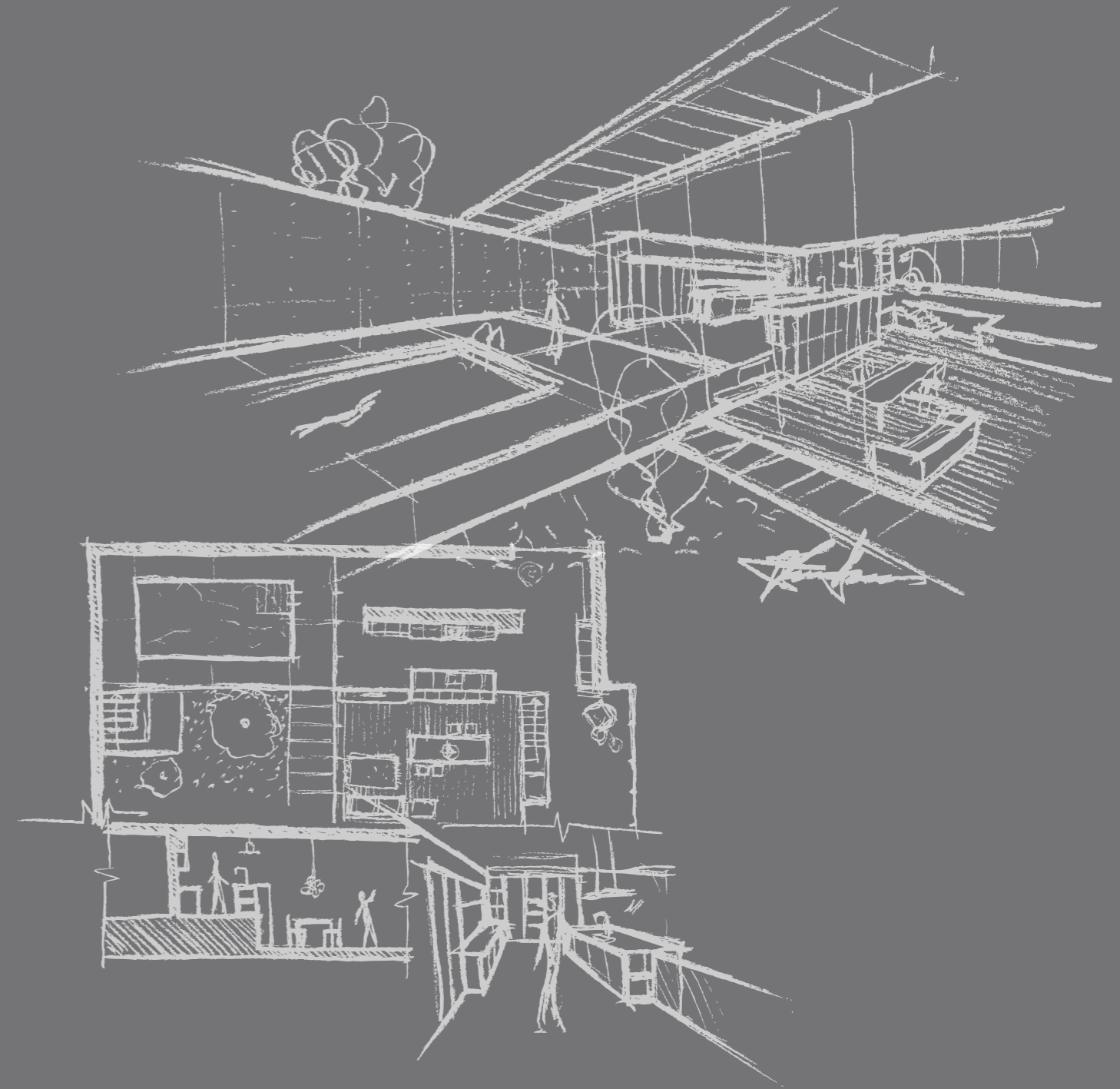









L'isola centrale, articolata su due livelli, diventa un elemento scenografico di raccordo tra cucina e zona living.

Il legno in rovere spazzolato Ardesia e il laccato Grigio Medio caratterizzano l'ambiente.

The central island, articulated on two levels, becomes a visual binding element between the living space and the kitchen.

The brushed Ardesia oak and the Grigio Medio lacquered characterise the environment.

L'îlot central, sur deux niveaux, devient un élément scénographique de connexion entre la cuisine et la zone living.

Le bois en chêne brossé Ardesia et le laqué Grigio Medio caractérisent cet espace.

La isla central, articulada en dos niveles, se convierte en un elemento escénico de unión entre la cocina y la zona living.

La madera de roble cepillado Ardesia y el lacado Grigio Medio caracterizan el ambiente.





La parete è attrezzata con la boiserie "Strato" ed un capiente gruppo colonne dispensa che comprendono l'elegante forno abbinato al microonde.

Le vetrine "Gem" completano la composizione occupando uno spazio di grande importanza nella distribuzione d'arredo.

La paroi est équipée en boiserie "Strato" et un spacieux groupe de colonnes rangement qui intègrent l'élégant four associé au micro-ondes.

Les vitrines "Gem" complètent la composition en jouant un rôle très important dans l'agencement des meubles.

The wall is fitted with the boiserie "Strato" and a capacious larder column unit which includes the elegant oven and matching microwave.

The "Gem" display cabinet completes the composition by occupying an important part of the distribution of the furniture.

La pared está equipada con la boiserie "Strato" y un grupo de columnas despensa de gran capacidad que incluyen el elegante horno acoplado al microondas.

Las vitrinas "Gem" completan la composición ocupando un espacio muy importante en la distribución de los muebles.





LACCATO LUCIDO BIANCO  
GLOSSY LACQUERED BIANCO

VETRINA "GEM" TELAIO BRUNITO  
VETRINA "GEM" BRUNITO FRAME

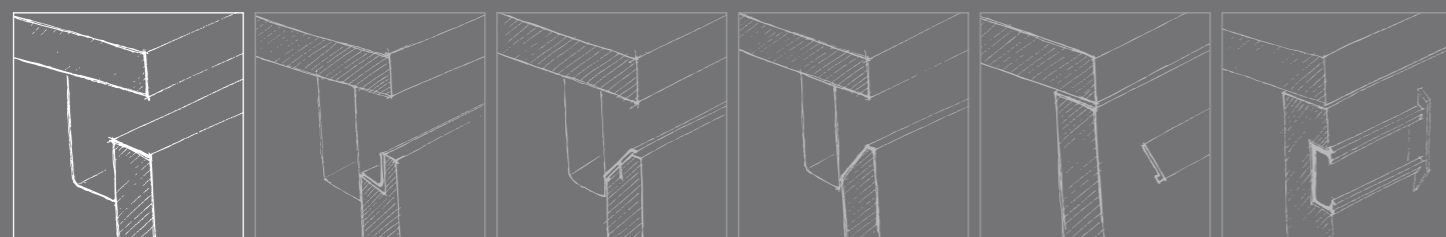









Una parete caratterizzata dalle colonne con larghezza "XL" per il contenimento di capienti elettrodomestici da 30". Il raffinato laccato Bianco lucido, rende il tutto particolarmente leggero ed elegante.

Il sistema di vetrine "Gem" viene utilizzato come pensili dotate di illuminazione interna a LED, vetro fumè Bronzo e telaio brunito.

A wall characterised by the "XL" tall cabinets, for containing the 30" wide appliances. The refined White gloss lacquer makes it look particularly light and elegant.

The "Gem" vetrina cabinet system is used as a wall unit fitted with internal LED lighting, fumè Bronzo glass and brunito frame.

Une paroi caractérisée par les colonnes de largeur "XL" pour y intégrer des électroménager de 30" de grande capacité. Le laqué blanc brillant, rend le tout particulièrement léger et élégant.

Le système de vitrines "Gem" est utilisé comme meubles hauts dotées d'éclairage intérieur à LED, verre fumè Bronzo et cadre brunito.

Una pared caracterizada por unas columnas de ancho "XL" para contener electrodomésticos de gran capacidad de 30". El refinado lacado Blanco brillante hace que todo sea particularmente ligero y elegante.

El sistema de vitrinas "Gem" se utiliza como muebles altos equipados con iluminación LED interior, vidrio fumè Bronzo y marco brunito.





Le innovative lampade "Focus\_On" scorrono su un binario centrale, per una illuminazione localizzata sul piano di lavoro dell'isola.

Composizione verticale con gli elementi contenitori "Shangai" retro illuminati a tutta altezza.

Les révolutionnaires lampes "Focus\_On" glissent sur un rail central pour un éclairage localisé sur le plan de travail de l'îlot.

Composizione verticale con gli elementi contenitori "Shangai" retroilluminati a tutta altezza.

The innovative "Focus\_On" lamps, slide on a central rail to localise illumination on the island's worktop.

Vertical composition with "Shangai" container elements, backlit for its entire height.

Las innovadoras lámparas "Focus\_On" se deslizan por un rail central, gracias a una iluminación localizada sobre la encimera de la isla.

Composición vertical con los elementos abiertos "Shangai" retroiluminados.







10

**ROVERE SPAZZOLATO** CARMEL  
OAK BRUSHED CARMEL

**LACCATO OSSIDATO** ACCIAIO  
OXIDIZED LACQUERED ACCIAIO

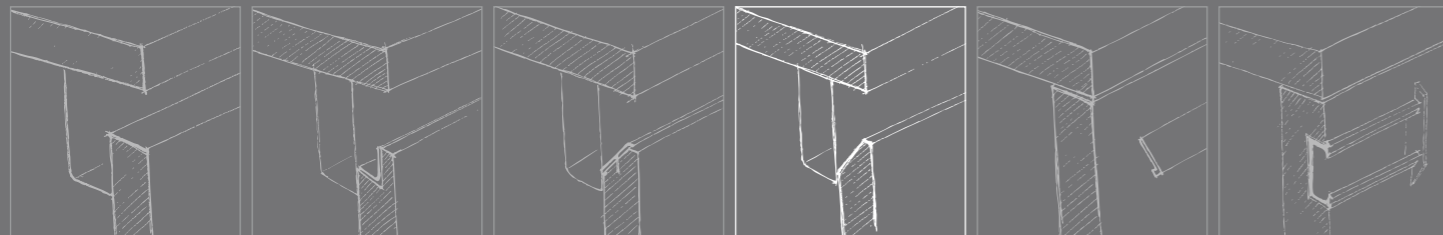
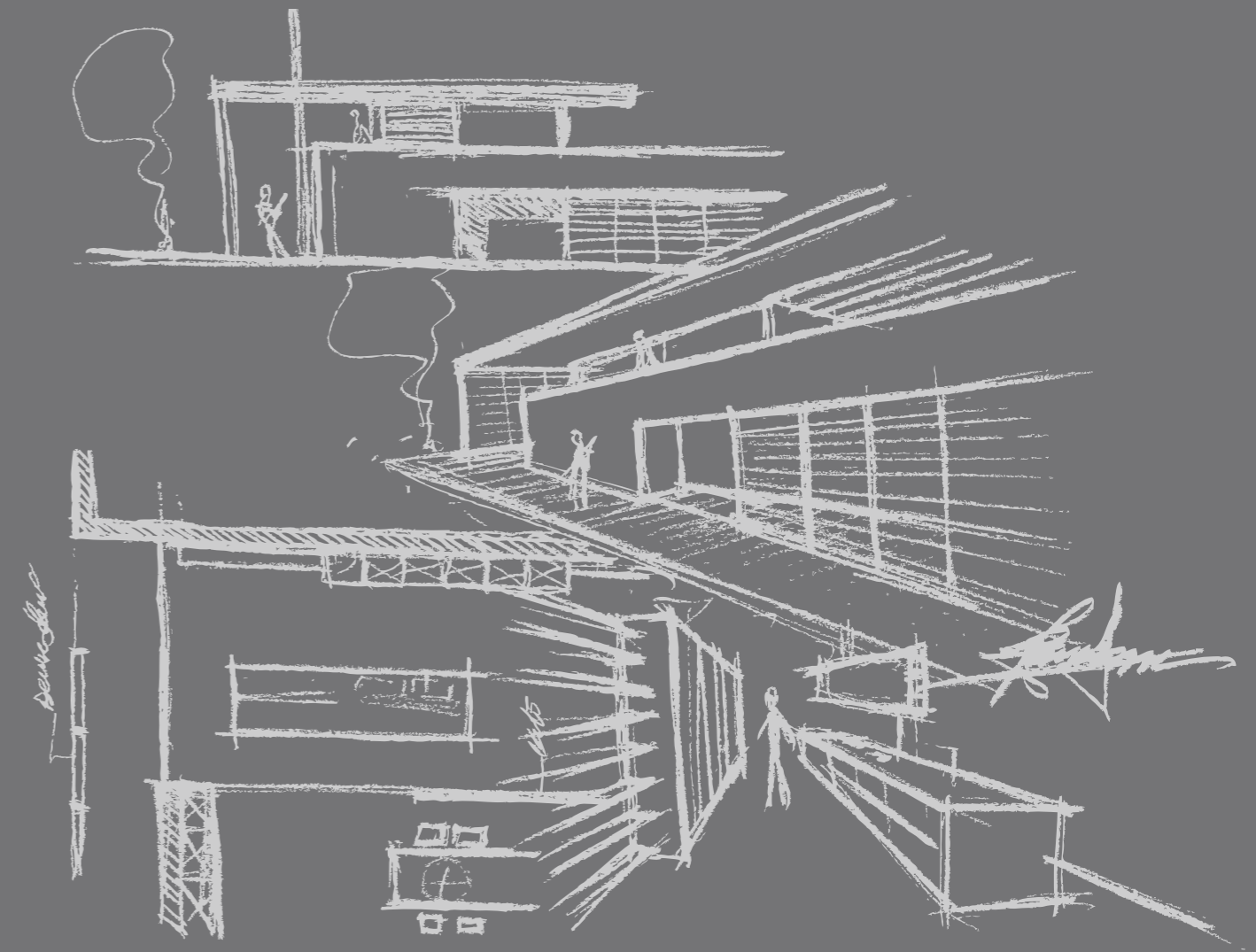









La preziosa verniciatura del laccato Ossidato abbinata al legno garantisce eleganza all'ambiente, ed il pratico piano in acciaio satinato attrezzato, aggiunge un tocco di professionalità in cucina.

L'imponente cappa di aspirazione viene rivestita con pannelli in finitura e dotata di sistema up-down a scomparsa.

The precious paint of the Oxidised lacquered, matched with the wood gives elegance to the space, and the practical satin steel worktop, gives a touch of professionalism in the kitchen.

The imposing extractor fan is covered with finished panels and is equipped with a hideaway up-down system.

La précieuse peinture en laqué Oxydée combinée avec le bois, garantit une élégante ambiance et son pratique plan en acier satiné, ajoute une touche de professionnalisme à la cuisine.

L'impressionnante hotte d'aspiration est recouverte de panneaux en finition et pourvue de système up-down rétractable.

El precioso barniz del lacado Oxidado a juego con la madera garantiza elegancia al ambiente, y la práctica encimera equipada de acero satinado, añade un toque de profesionalidad en la cocina.

La impresionante campana extractora está revestida con paneles de acabado y equipada con el sistema up-down retráctil.





Il gruppo colonne è organizzato con la modularità disponibile per il mercato americano.

A completamento della composizione una boiserie con schiena in finitura rovere spazzolato Caramel e mensole in laccato Ossidato.

Le groupe colonnes est agencé avec la modularité disponible pour le marché américain.

Pour compléter la composition, une boiserie avec dos en chêne brossé couleur Caramel et des étagères en laqué Oxydé.

The tall units are designed with the American modules.

Completing the composition, a boiserie with back panels finished in Caramel brushed oak, and Oxidised lacquered shelves.

El grupo de columnas está presentado con la modularidad disponible para el mercado americano.

Para completar la composición hay una boiserie con trasera en acabado roble cepillado Carmel y estantes en lacado Oxidado.





11

LACCATO SAND ARENA  
SAND LACQUERED ARENA

VETRINA "GEM" TELAIO ARDESIA  
VETRINA "GEM" ARDESIA FRAME

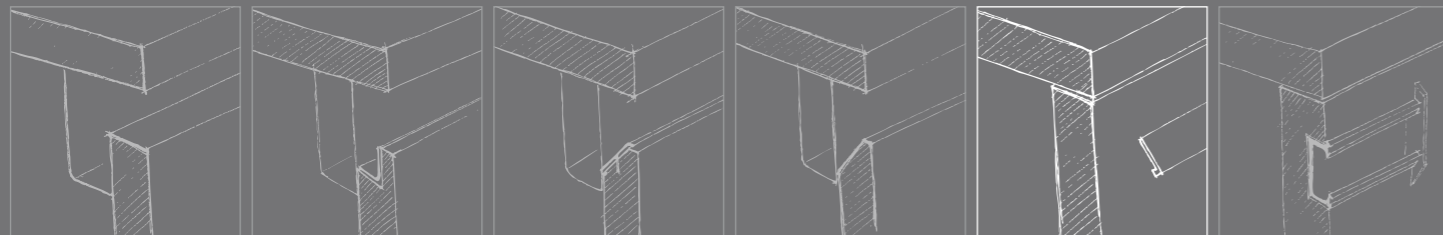
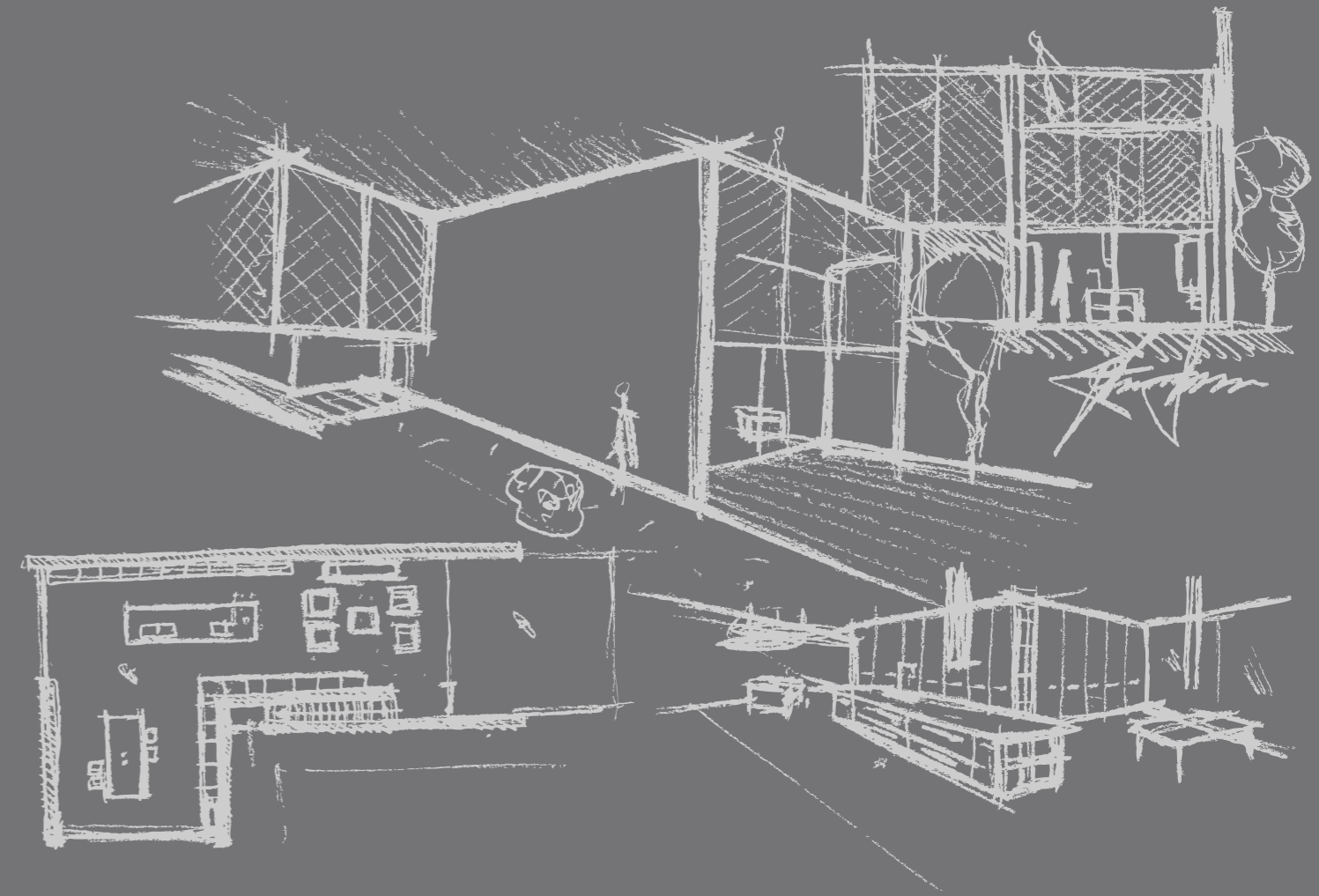









Il sistema delle colonne, con gli elettrodomestici integrati, offre la possibilità di organizzare una pratica cabina armadio che ne aumenta la possibilità di gestione degli spazi.

The tall units system, with integrated appliances, offers the possibility to organise a practical larder which increases the space management possibilities.

Le système de colonnes, avec les électroménagers intégrés, offre la possibilité d'organiser un pratique cabine armoire qui augmente la possibilité de gestion des espaces.

El sistema de columnas, con los electrodomésticos integrados, ofrece la posibilidad de organizar un práctico armarío que aumenta la posibilidad de la gestión del espacio.

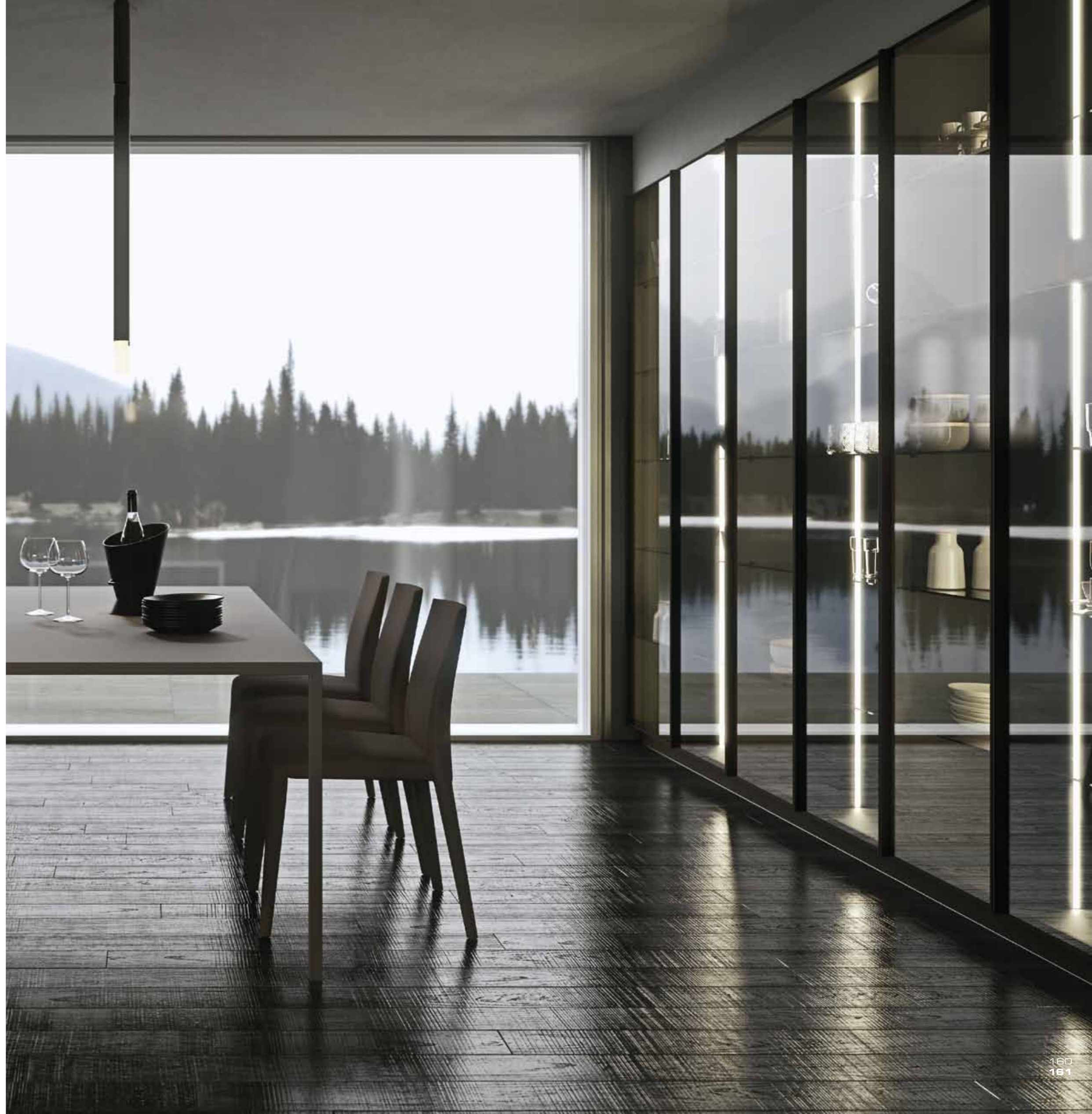



Ampio spazio domestico in cui domina l'isola centrale sulle cui estremità vengono inseriti i moduli terminali a giorno verniciati in tinta.

I cestoni vengono attrezzati per ottenere la massima capacità contenitiva con elementi separatori flessibili.

La maniglia modulare, in tinta con le ante, è caratterizzata dal sistema di fissaggio a scomparsa brevettato.

An ample domestic space where the central island dominates, on to which open shelf modules are added, painted to match.

The baskets are equipped so as to offer the maximum containing capacity with flexible separator elements.

The modular handle, matching the doors, is characterised by a patented hideaway fixing system.

Grand espace d'intérieur dans lequel domine l'îlot central dont les extrémités abritent des modules appropriés ouverts et de la même couleur.

Les coulissants sont équipés pour obtenir une capacité de rangement maximale avec des éléments de séparation personnalisable.

La poignée modulaire, de la même couleur que les portes, est caractérisée par le système de fixation breveté invisible.

Un gran espacio doméstico en el que domina la isla central, donde en los extremos se insertan módulos terminales abiertos lacados del mismo color.

Las gabetas están equipadas para obtener la máxima capacidad de almacenamiento con elementos separadores flexibles.

El tirador modular, del mismo color que las puertas, se caracteriza por un sistema de fijación oculto.



Un ampio spazio operativo circonda il lavello sotto top e piano cottura ad induzione che trovano alloggio nel piano in agglomerato di quarzo dell'isola.

Un grand espace de travail entoure l'évier sous-plan fleur et plaque de cuisson à induction qui sont logés dans le plan en aggloméré de quartz de l'îlot.

An ample working space surrounds the under-mounted sink and induction hob which are housed in the quartz agglomeration worktop of the island.

Una amplia zona de trabajo rodea el fregadero bajo encimera y la placa de cocción de inducción que se alojan en la encimera de aglomerado de cuarzo de la isla.





ACCIAIO SATINATO  
STEEL SATINATO

ROVERE SPAZZOLATO TATTI  
OAK BRUSHED TATTI

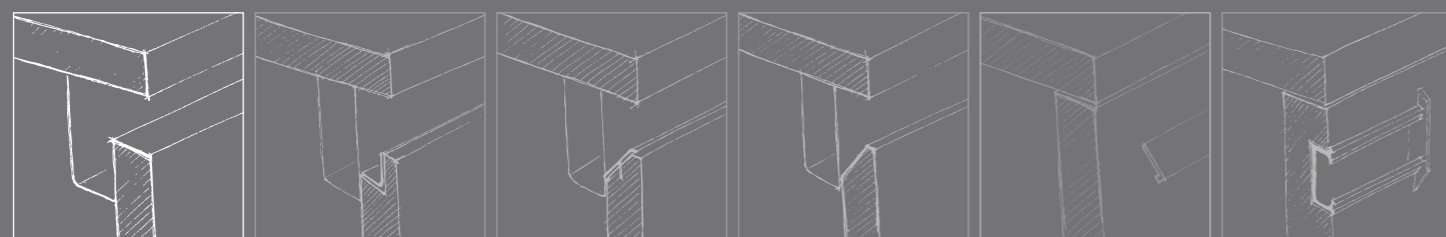
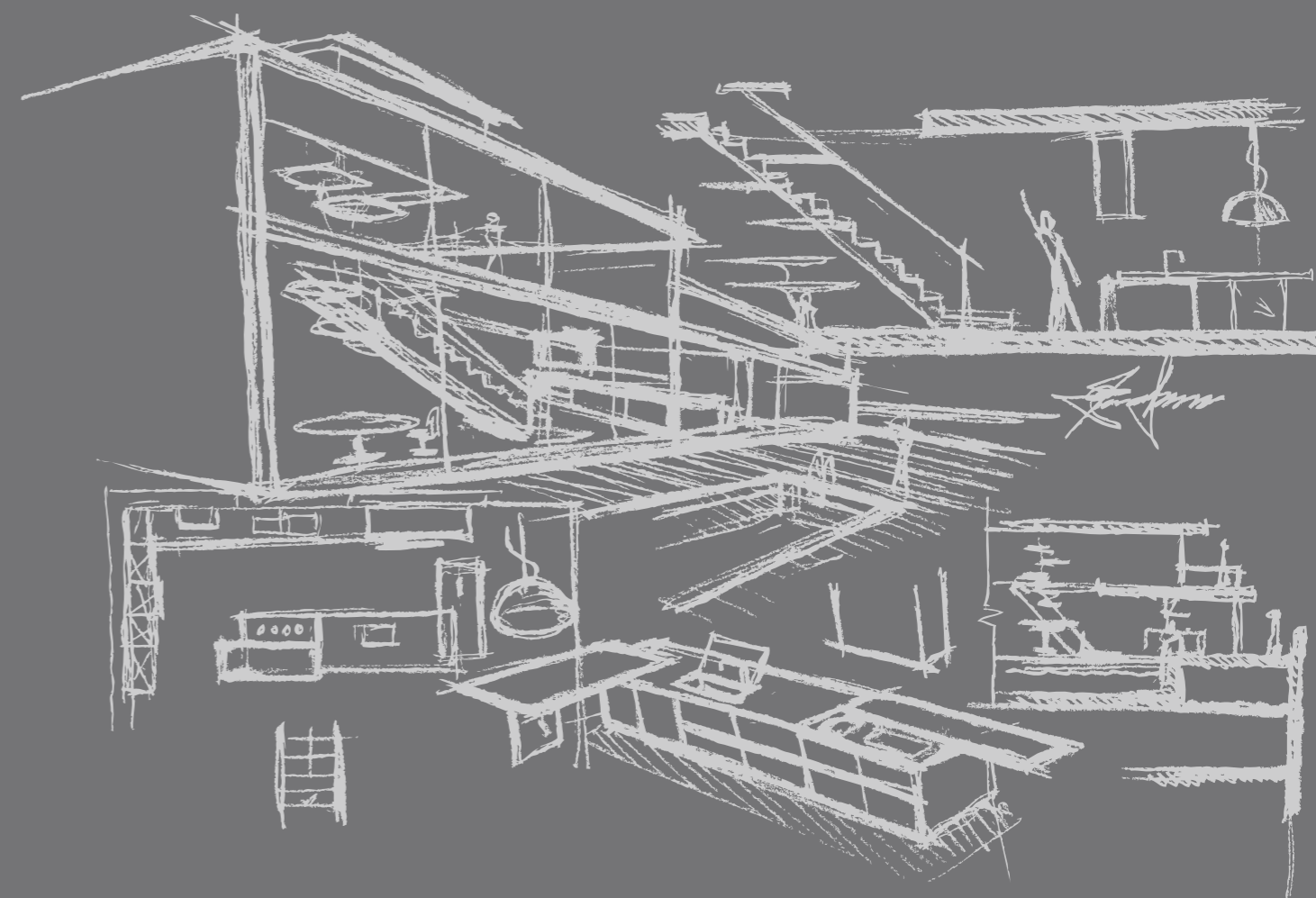











L'isola interamente rivestita in acciaio satinato con attrezzature saldate a filo, conferisce all'ambiente la tecnicità delle cucine professionali.

Un piano snack rivestito in legno sembra sospeso grazie all'utilizzo del gambone strutturale in vetro.

L'accostamento a contrasto dei materiali sottolinea la purezza formale della composizione.

The island is entirely covered in satin steel with flush-mounted equipment, giving the environment the technical feel of a professional kitchen.

A snack bench top covered in wood, appears to be suspended thanks to the use of glass structural legs.

The contrasting juxtaposition of materials underlines the formal purity of the composition.

L'îlot entièrement recouvert en acier satiné avec les équipements soudés à fleur, donne à la pièce la technicité des cuisines professionnelles.

Un plan snack revêtu en bois semble être suspendu grâce à l'utilisation du pied en verre.

La combinaison des matériaux souligne la pureté formelle de la composition.

La isla, completamente revestida de acero satinado con electrodomesticos soldado a ras, aporta al ambiente un toque de "tecnicidad" propio de las cocinas profesionales.

La barra de snack revestida de madera parece suspendida gracias al uso de la pata estructural de vidrio.

La combinación a contraste con los materiales utilizados destaca la pureza formal de la composición.



All'interno del canale attrezzato in acciaio, un modulo cablato a scomparsa con prese indipendenti rende il piano di lavoro funzionale all'utilizzo di piccoli elettrodomestici o strumenti tecnologici.

I lavelli in acciaio sono dotati di rubinetto abbattibile e coperchio ribaltabile filo.

A l'intérieur du canal aménagé en acier, un module rétractable câblé avec des prises indépendantes rend le plan de travail fonctionnel à l'utilisation de petits électroménagers ou des outils technologiques.

Les éviers en acier sont équipés de robinet et de couvercle rabattables à fleur.

Inside the fitted steel conduit, a cabled hideaway module with individual sockets makes the worktop functional for using small kitchen tools or electrical items.

The steel sinks are fitted with pull-out taps and flush-fitting flap cover.

Dentro al canal equipado de acero, hay un módulo para cables oculto con salidas independientes sobre la encimera para el uso de pequeños electrodomésticos o aparatos tecnológicos.

Los fregaderos de acero están equipados con grifo plegable y tapa abatible a ras.





**22** mm

**SPESSORE ANTA**  
DOOR THICKNESS  
ÉPAISSEUR FAÇADE  
GROSOR DE PUERTA

**\_79 \_82**

**ALTEZZA FUSTO**  
CARCASE HEIGHT  
HAUTEUR CAISSON  
ALTURA CASCO

**3**

**6 - 8 - 10** cm

**ALTEZZA ZOCCOLI**  
PLINTH HEIGHT  
HAUTEUR SOCLE  
ALTURA ZOCALO

**6**

**TIPOLOGIA APERTURA ANTA**  
DOOR OPENING TYPES  
TYPOLOGIE D'OUVERTURE FAÇADE  
TIPOLOGIA DE APERTURA DE PUERTAS

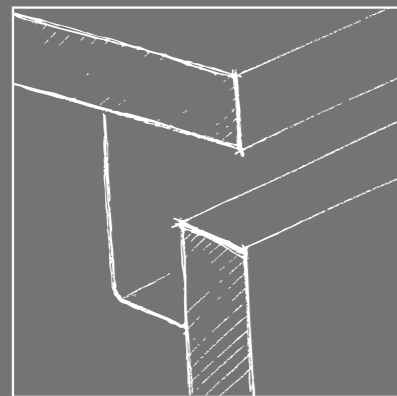

**BORDO DRITTO**  
STRAIGHT EDGE  
CHANT DROIT  
CANTO RECTO

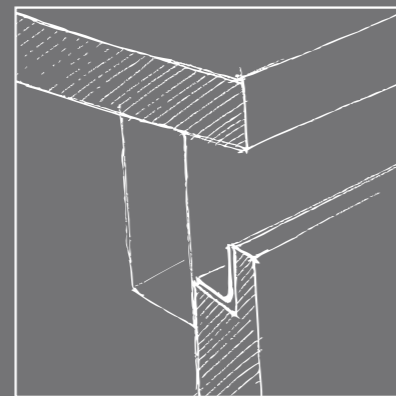

**PROFILO A STEP**  
"STEP" HANDLE PROFILE  
PROFIL "STEP"  
PERFIL "STEP"

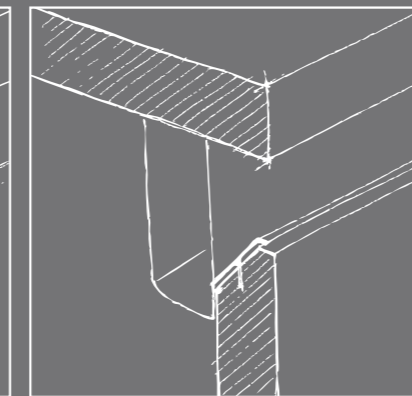

**PROFILO 30°**  
30° PULL GRIP PROFILE  
PROFIL 30°  
PERFIL 30°

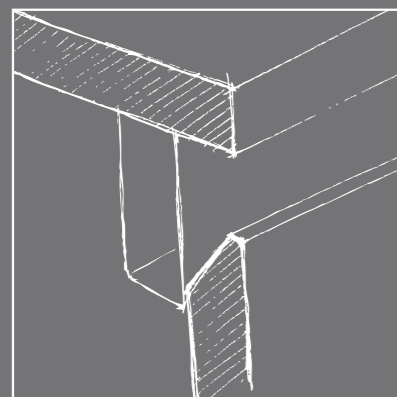

**BORDO 30°**  
30° CUT EDGE  
CHANT 30°  
CANTO 30°

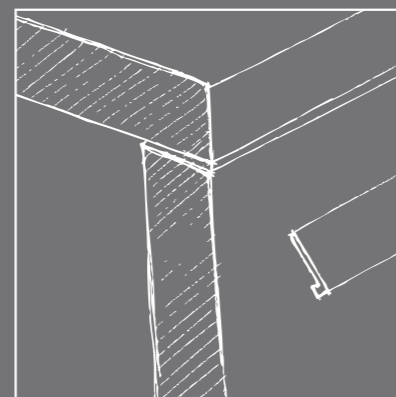

**MANIGLIA ESTERNA**  
HANDLE  
POIGNÉE EXTERNE  
TIRADOR

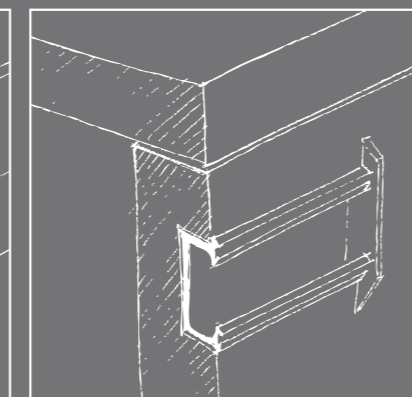

**MANIGLIA INCASSO**  
RECESSED HANDLE  
POIGNÉE ENCASTRÉE  
TIRADOR EMPOTRADO

## FINISHES

**25** **MELAMINICI**  
MELAMINE  
MELAMINÉ  
MELAMINICO

**4** **TECNOLUX**

**3** **FENIX**

**20** **LACCATI LUCIDI/SAND**  
GLOSSY/SAND LACQUERED  
LAQUES BRILLANT/SAND  
LACADOS BRILLO/SAND

**3** **LACCATI OSSIDATI**  
OXIDISED LAQUERED  
LAQUES OXYDÉ  
LACADOS OXIDADO

**10** **ROVERE SPAZZOLATO**  
BRUSHED OAK  
CHÊNE BROSSÉ  
ROBLE CEPILLADO

**2** **ACCIAIO**  
STEEL  
ACIER  
ACERO

**Melaminico** - Melamine - Melaminé - Melaminico

**SCOCCA**  
CARCASE  
CAISSON  
CASCO



Bianco

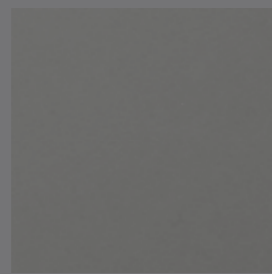

Grigio Steel

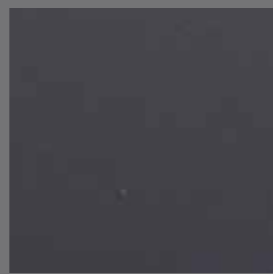

Grafite

**TERMOSTRUTTURATO PORO REGISTRO**  
THERMOSTRUCTURED PORO REGISTRO  
THERMO STRUCTURÉ MATERICO PORO REGISTRO  
TERMOSTRUCTURADO PORO REGISTRO



Ghiaccio



Pergamena

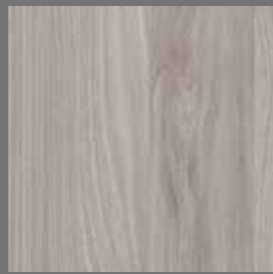

Loft

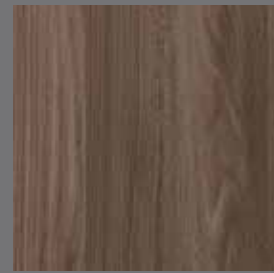

Sughero

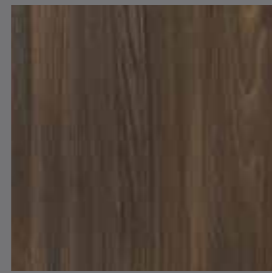

Caffè



Daino



Silver



Sherwood

**SUPERMATT**  
SUPERMATT  
SUPERMATT  
SUPERMATT

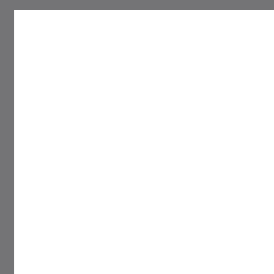

Bianco

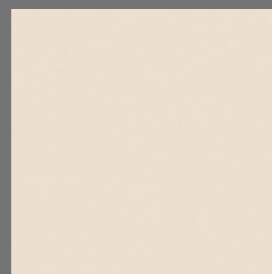

Avorio



Creta



Shadow

**TERMOSTRUTTURATO SABBATO**  
THERMOSTRUCTURED SABBATO  
THERMO STRUCTURÉ SABBATO  
TERMOSTRUCTURADO SABBATO

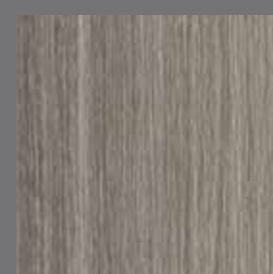

Basalto

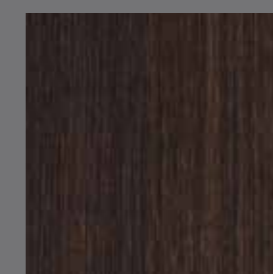

Moro

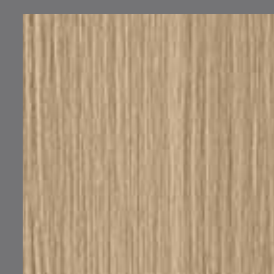

Fox



Riso



Sesamo



Paglia

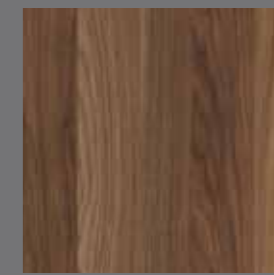

Noce

**TERMOSTRUTTURATO MATERICO**  
THERMOSTRUCTURED MATERICO  
THERMO STRUCTURÉ MATERICO  
TERMOSTRUCTURADO MATERICO



Wall73



Wall45



Wall51

**TEXTURE**  
TEXTURE  
TEXTURE  
TEXTURE



Perla



Tufo



Etna

## TECNOLUX

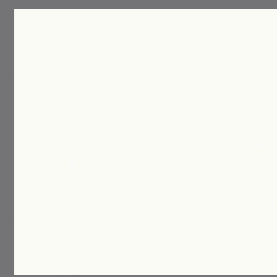

Bianco

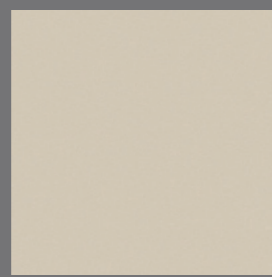

Vaniglia

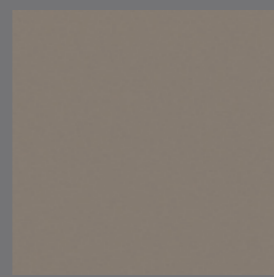

Gianduia

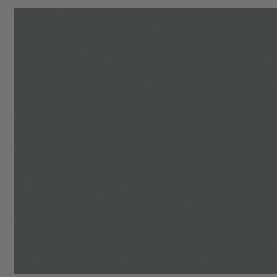

Fumo

## FENIX NTM®

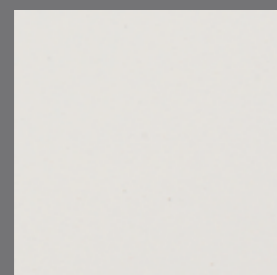

Bianco Malè



Grigio Londra

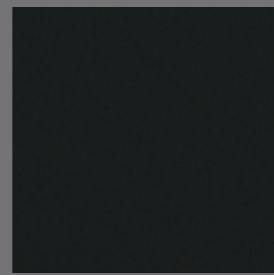

Nero Ingo

## Rovere Spazzolato - Oak Brushed - Chêne Brossé - Roble Cepillado

IMPIALLACCIATO  
VENEERED  
PLACAGE BOIS  
CONTROCHAPADO



Nuvola



Tatti

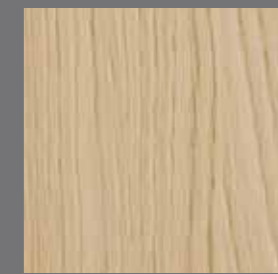

Naturale

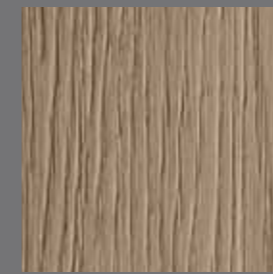

Avana



Corteccia



Cacao



Caramel



Portland

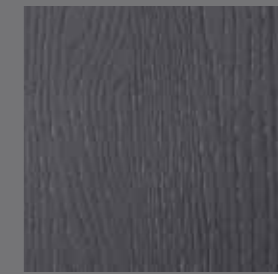

Ardesia

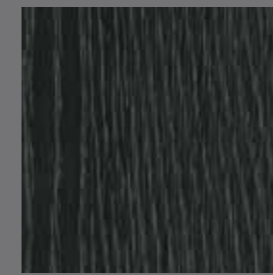

Carbone

## Acciaio Inox - Stainless Steel - Acier Inox - Acero Inox



Satinato

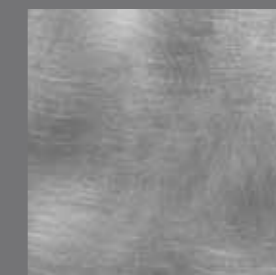

Vintage

## Laccato Ossidato

Oxidised Laquered - Laqué oxidé - Lacado oxidado



Acciaio



Bronzo



Piombo

## Laccati Lucidi/Sand

Lacquered Glossy/Sand - Laque Brillant/Sand - Lacado Brillant/Sand



Bianco Puro

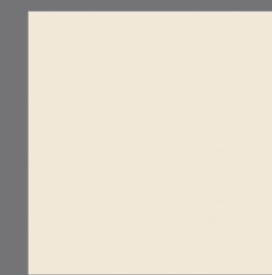

Bianco Crema

Ral 9001



Mandorla

NCS S 1502-Y50R



Grigio Chiaro

Ral 000.80.00

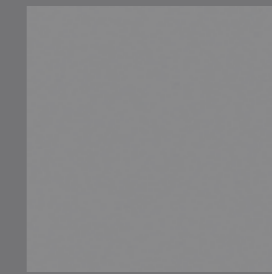

Grigio Fine



Grigio Medio

Ral 000.45.00



Grigio

Ral 7043



Ardesia

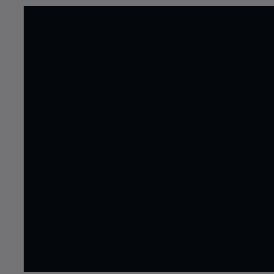

Nero

Ral 9005



Arena

Ral 060.60.05



Castoro Ottawa



Grigio Londra



Fango



Aston

NCS S7010-G50Y



Rosmarino



Verde Eco



Petrolio

Ral 230.30.20



Giallo Ambra



Arancio

Ral 3016



Rosso Rubino

Ral 3003



RAL / NCS

# Ak\_Project | ACCESSORIES

AkB\_Case - AkB\_Case - AkB\_Case - AkB\_Case



DayBox - DayBox - DayBox - DayBox



Vani a giorno - Open units - Niches ouvertes - Huecos abiertos



Shangai - Shangai - Shangai - Shangai



Strato - Strato - Strato - Strato

Cabina angolo dispensa - Walk-in corner pantry  
Cabine d'angle rangement - Cabina angular despensero



Focus\_On - Focus\_On - Focus\_On - Focus\_On - Focus\_On





THANKS TO

ARPER  
BSB ITALIA  
BOCCI  
BONALDO  
CARL HANSEN  
CASSINA  
DCW ÉDITION  
DRIADE  
EDRA  
FLOS  
FOSCARINI  
FRITZ HANSEN  
GLAS ITALIA  
GYROFOCUS  
HAY  
INGO MAURER  
KASTEL  
KNOLL  
LIGHT DROPS DESIGN  
LIGNE ROSET  
LUCE PLAN  
MAGIS  
MDF ITALIA  
MINOTTI  
MOROSO  
PETITE FRITURE  
POLIFORM  
SECTO DESIGN  
THONET  
VICCARBE HABITAT  
VITRA

P R E M I O



**ARRITAL Spa - Premio 100 ECCELLENZE ITALIANE**  
Palazzo Montecitorio ROMA 1 dicembre 2016



**ARRITAL Spa - Corporate Identity Program**  
The Chicago Athenaeum Museum Of Architecture And Design - Winner 2012



Design and Art Direction

**ARCH. FRANCO DRIUSSO**

Graphic Design and Stylist

**DRIUSSO ASSOCIATI | ARCHITECTS**

Images Production

**Nerokubo**

Color Separation

**Luce Group**

Printed

**AGCM 01/2017**